

Integrated Remote Commander

Operating Instructions

RM-AV2100/AV2100B

WARNING

To prevent fire or shock hazard, do not expose the unit to rain or moisture.

To avoid electrical shock, do not open the cabinet. Refer servicing to qualified personnel only.

WARNING

You are cautioned that any changes or modifications not expressly approved in this manual could void your authority to operate this equipment.

For the customers in the USA

Owner's Record

The model number is located on the front panel.

The serial number is located on the inner side of the battery compartment.

Record these numbers in the spaces provided below. Refer to them whenever you call upon your Sony dealer regarding this product.

Model No. RM-AV2100B

Serial No.

NOTICE FOR THE CUSTOMERS IN THE U.S.A.

NOTE

This equipment has been tested and found to comply with the limits for a Class B digital device, pursuant to Part 15 of the FCC Rules. These limits are designed to provide reasonable protection against harmful interference in a residential installation. This equipment generates, uses, and can radiate radio frequency energy and, if not installed and used in accordance with the instructions, may cause harmful interference to radio communications. However, there is no guarantee that interference will not occur in a particular installation. If this equipment does cause harmful interference to radio or television reception, which can be determined by turning the equipment off and on, the user is encouraged to try to correct the interference by one or more of the following measures:

- Reorient or relocate the receiving antenna.
- Increase the separation between the equipment and receiver.
- Connect the equipment to an outlet on a circuit different from that to which the receiver is connected.
- Consult the dealer or an experienced radio/TV technician for help.

Features

The RM-AV2100 Remote Commander provides centralized control of all your AV components from a single remote commander and saves the trouble of operating different AV components with different remote control devices. The following are its main features.

Centralized control of Sony AV components with this one remote commander

This Commander is preset at the factory to operate Sony brand components, so you can use it out of the box as a control center for your Sony AV components.

Remote control signals for non-Sony components are also preset

This Commander is preset for most major brands components including Sony. You can remote control your components by setting their code numbers (page 8).

Learning function for programming other remote control signals you need

This Commander has a learning function, to learn remote control signals to operate non-preset components or functions (page 16).

In addition, the Commander can learn remote control signals (infrared signals only) of non-Audio Visual components such as air-conditioners, lights, etc. (some specific appliances or functions may not be available) (page 38).

Reassigning new components

You can assign other Component Select Buttons to freely operate other components. This is useful when you have more than two of the same kind of AV components (page 35).

System Control function allows one-touch operation to execute a series of commands

You can program up to 16 consecutive operation steps to execute a series of operations by pressing a single button (page 23).

Data can be transferred among remote commanders with the mark

You can transfer the data such as learned signals and component code settings between this Commander and another Sony remote commander with the  mark. It will save you the trouble of performing the same operations again for setting (page 41).

Channel macro function allows you to select a channel with a single key

Up to 4 key steps can be programmed on macro keys. If you set the key operations for entering a channel number on a macro key, you can select the channel by pressing that macro key (page 45).

Easy-to-operate touch key LCD with blue back light

This Commander has a touch key LCD that changes the key display according to the selected component. The Commander is easy to operate as only the keys necessary to operate the selected component are displayed. The display backlight allows operation even in the dark.

Table of Contents

Getting Started

Installing the Batteries	6
When to replace the batteries	6
Location and Function of Controls	7

Basic Operations

Setting the Code for Preset Audio and Visual Components	8
Setting a component code	8
Checking if the code number works	10
Finding a component code with the Search function	11
Operating Your Components with the Remote Commander	13
To control the volume	14
Notes on operating your components	15
Using Non-Preset Remote Control Operations — Learning Function	16
For accurate learning	20
Changing or erasing the function of a taught key or button	20

Advanced Features

Controlling the Volume of Visual Components Connected to an Audio System	22
Executing a Series of Commands — System Control Functions	23
Programming a series of commands to the SYSTEM CONTROL buttons	24
Notes on System Control Operations	27
Programming a series of commands to the Component Select buttons	28
Changing the interval between operation steps	30
Adding an Extra Function to the Component Select Buttons	31
Programming the Power-On command of the selected component (for Sony components only)	31
Adding a command that is required when selecting a component	32
Turning Off the Power of All Components with the Touch of a Single Button — System Power-Off Function (for Sony Components only)	34
Assigning Other Components to the Component Select Buttons	35
Copying the settings of a Component Select button to another button	37
Programming a Frequently Used Key Operation for SYSTEM CONTROL Buttons	38
Notes on learning the signals of an air-conditioner	40
Transferring Data between Remote Commanders	41
Transferring data	41
Receiving the data	43

Selecting a Channel with a Single Key Press — Channel Macro Function	45
--	----

Using Other Functions

Locking the Controls — Hold Function	47
Protecting your settings — Preset Lock Function	48
Changing the Auto Power-Off Time of the Commander	49
Adjusting the Backlight of the Display Window	50
Setting the Key-Touch Beep	51
Changing the Touch-Key Display	52

Additional Information

Precautions	54
Maintenance	54
Specifications	54
Troubleshooting	55

Appendix

Table of Preset Functions	58
TV	58
VCR 1, 2, 3	59
DVD	59
VD (LD player)	60
CBL (Cable box)	60
SAT	61
AMP	61
CD	62
MD	63
DAT	63
DECK B/A	64
TUNER	64
DSP (Digital Surround Processor)	65
LCD Touch-Key Display Table	66
Quick Reference of Operations	74
Index	Back cover

Installing the Batteries

Slide open the battery compartment lid and insert four size AA (R6) batteries (not supplied). Be sure to line up the + and - on the batteries with the + and - on the battery compartment.

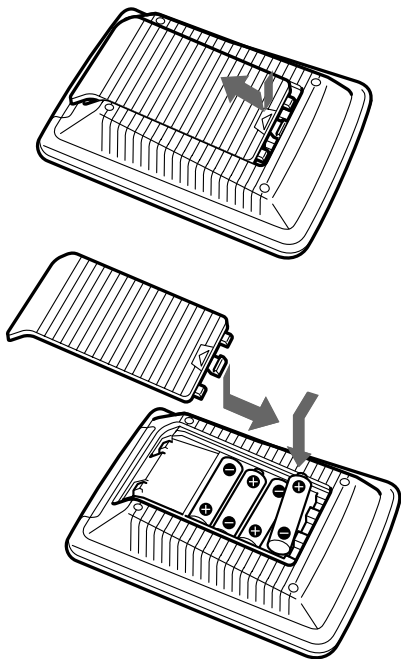

When to replace the batteries

Batteries for remote control operation and backlight (four size AA (R6) batteries)

Under normal conditions, batteries will last up to 5 months. If the Commander does not operate properly, batteries might be worn out and  is displayed on the LCD touch panel. When the display dims or the backlight for the touch keys grows dim, replace the batteries with new ones.

Note

Do not take more than one day to replace the batteries; otherwise, your setting of the code numbers (page 8) and learned remote control signals (page 16) will be erased.

Notes on batteries

- Do not mix old batteries with new ones or mix different types of batteries together.
- If the electrolyte inside the battery should leak, wipe the contaminated area of the battery compartment with a cloth and replace the old batteries with new ones. To prevent the electrolyte from leaking, remove the batteries when you plan not to use the Commander for a long period of time.

Location and Function of Controls

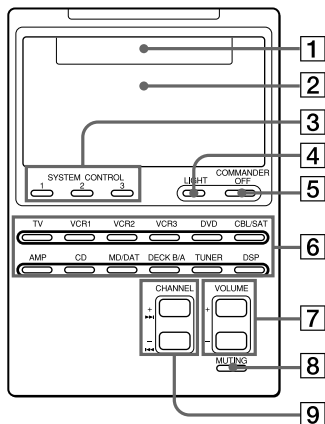

- 1 Component display area**
Displays the name of the component selected.
- 2 LCD touch key display (page 11)**
The keys used for operating each component are displayed.
Note
Do not press the touch keys using sharp objects such as pins or ball-point pens.
- 3 SYSTEM CONTROL buttons (page 23)**
You can program up to 16 consecutive key operations to each of the three SYSTEM CONTROL buttons. You can automatically carry out the entire program by pressing one button.
- 4 LIGHT button (page 50)**
Used to light up the LCD display in the dark. Press the button once to turn on the light, and once again to turn it off. You can also set the backlight to go off automatically after a certain period of time.

- 5 COMMANDER OFF button**
Turns the power of the Commander off.
- 6 Component Select buttons**
Selects the component to control.
- 7 VOLUME +/- buttons* (page 14, 22)**
Adjust the volume.
- 8 MUTING button* (page 14, 22)**
Mutes the audio. Press the button once again to resume at the previous volume.
- 9 CHANNEL +/- buttons**
Select the channel.

* **Note on the VOLUME +/- and MUTING buttons**

The Commander controls or mutes the TV's volume when you select a visual component. The Commander controls or mutes the amplifier's volume when you select an audio component. You can change this setting also (page 22).

Note on the power on and off of the Remote Commander

To turn on the power, press any button except the COMMANDER OFF button. To turn off, press COMMANDER OFF, or if you don't use the Commander, it automatically turns off after 10 minutes. This interval can also be changed (page 49).

Setting the Code for Preset Audio and Visual Components

The Commander is preset at the factory to operate Sony brand AV components (see the table below). If you are using the Commander with a factory-set Sony components, skip the following procedures.

You can use the Commander with other preset AV components also. To use with other AV components, you need to follow the procedures to set the correct codes for each component.

Component Select Button	Preset component(s)	Factory setting
TV	TV TV/VCR Combo	Sony TV
VCR1	VCR	Sony VHS VCR (VTR3)
VCR2	VCR	Sony 8mm VCR (VTR2)
VCR3	VCR	Sony Beta VCR (VTR1)
DVD	DVD player (DVD)/LD player (VD)	Sony DVD player
CBL/SAT	Cable box (CBL)/Satellite tuner (SAT)	Sony satellite tuner (SAT)
AMP	Amplifier	Sony amplifier
CD	CD player	Sony CD player
MD/DAT	MD deck/DAT deck	Sony MD deck
DECK B/A	Cassette deck*	Sony cassette deck
TUNER	FM/AM tuner	Sony FM/AM tuner
DSP	Surround processor	Sony digital surround processor

* Analog audio compact cassette deck

See “Table of Preset Functions” (page 58) for the functions of keys and buttons as for each component.

Setting a component code

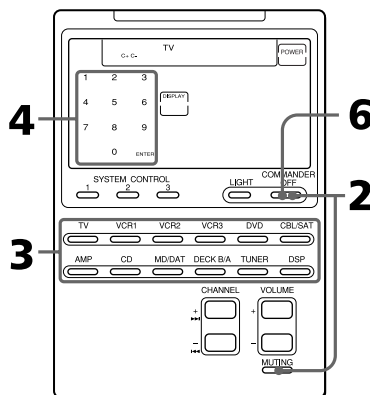

Example: To set up a Philips' TV

- 1 See the tables in the supplied "Component Code Numbers", and find the three-digit code number for the desired component.

If more than one code number is listed, use the number that is listed first.

For example, to set up a Philips' TV, you would use the code number 056.

- 2 While pressing COMMANDER OFF, press MUTING.

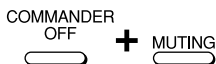

All the component names in the display flash.

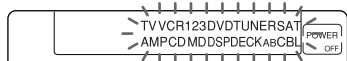

- 3 Press the Component Select button for the desired component.



The selected component remains displayed, and the 0 - 9, ENTER and DISPLAY keys flash.

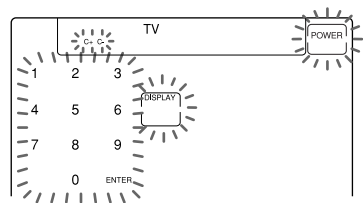

Note on the DVD and CBL/SAT buttons

When you set the component code of the DVD or CBL/SAT button, press repeatedly until the desired component is displayed ("DVD" or "VD", "CBL" or "SAT").

Note on the DECK B/A button

You have to set one component code each for DECK A and DECK B. Press the DECK B/A button repeatedly until the desired deck is displayed ("DECK A" or "DECK B"), and set a component code for it.

- 4 Press the three-digit component code number followed by the ENTER key on the touch-key display.

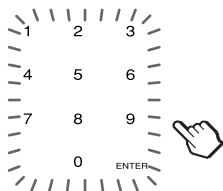

A beep sounds, and the code number and "ENTER" appear twice.

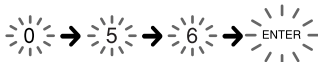

- 5 If you want to set a code for another component, repeat Steps 3 and 4.

- 6 Press COMMANDER OFF.



Setting the Code for Preset Audio and Visual Components (continued)

Notes

- If you press a component code number that is not on the table in the supplied "Component Code Numbers", the Commander beeps and "NG" flashes after you press the ENTER key. If this happens, check the component code number, and try setting again.
- If you don't input anything into the Commander for over two minutes between each step, the setup procedure will be canceled. To set the code, you must again press MUTING while pressing COMMANDER OFF.

To check which code number is set

Press the DISPLAY key in Step 3 to 5. The code number and "ENTER" appear twice.

Checking if the code number works

- 1 Press the corresponding Component Select button for the component you have set up.

TV



The Commander turns on and the touch-keys appear on the display.

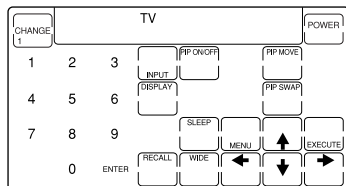

- 2 Power on the component with its power switch.

- 3 Aim the Commander at the component and press the POWER key in the touch-key display.



When the remote control signal is sent,  is displayed on the display.



The component should power off.

- 4 If you have succeeded, check that the Commander is operating the other functions of your component, such as channel and volume control.
See page 13 for details.

5 Press COMMANDER OFF.

COMMANDER
OFF



If the Commander does not seem to be working

Try repeating these setup procedures using the other codes listed for your components (see page 8).

Notes on keys which have "learned" a remote control signal already

If another signal has already been programmed on that key or button by the learning function (page 16), that "learned" signal will work even after you set the component code number. To use it as a preset component key or button, first erase its learned signal (page 20).

Note on the touch-key display

When you set a component code number, only the keys that have been preset with the signals for the desired component will be displayed. Preset signal of each key varies according to the brand. By using the learning function, you can program remote control signals to both the displayed keys and keys that are not displayed (see page 16). You can also choose either the full-function display or the basic-function display (page 52).

Finding a component code with the Search function

You can find a code number available for a component that doesn't have one in the supplied "Component Code Numbers".

Before starting the Search function

Set each component to the following status to enable the Search function.

TV: Power-on

VCR, DVD, SAT, CBL, AMP: Power-off

VD, CD, MD, TAPE: Power-on with a playback source (disc, cassette tape, etc.)

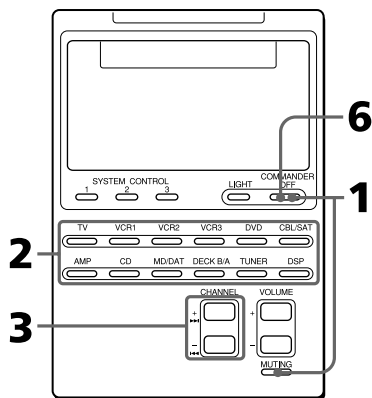

Setting the Code for Preset Audio and Visual Components (continued)

- 1 While pressing COMMANDER OFF, press MUTING.

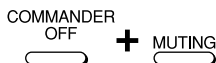

All the component names on the display flash.

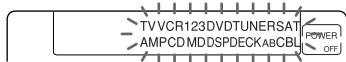

- 2 Press the Component Select button for the desired component.

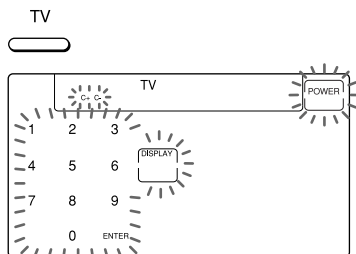

- 3 Press CHANNEL + or CHANNEL -.

Press CHANNEL + to go to the next code number.

Press CHANNEL - to go back to the previous code number.

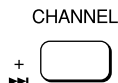

- 4 Aim the Commander at the component and press the POWER key.



When the remote control signal is sent,  is displayed on the display.

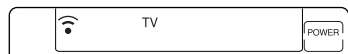

If it successfully works (power-off for TV, power-on for VCR, DVD, SAT, CBL, AMP, and playback for VD, CD, MD, TAPE), go to Step 5. If it doesn't, repeat Steps 3 and 4.

- 5 Press the ENTER key.

A beep sounds, and the code number and "ENTER" appear twice.

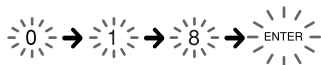

Note

It is recommended to write down the code number.

- 6 Press COMMANDER OFF.



To check which code number is set

Press the DISPLAY key in Step 2 and 5. The code number and "ENTER" appear twice.

Be sure to press the DISPLAY key after you have pressed the ENTER key to set the code number. If you press the DISPLAY key before the code number is set, it returns back to the first number at which you started searching.

Operating Your Components with the Remote Commander

When you operate a non-Sony component, make sure you set the component code first (page 8).

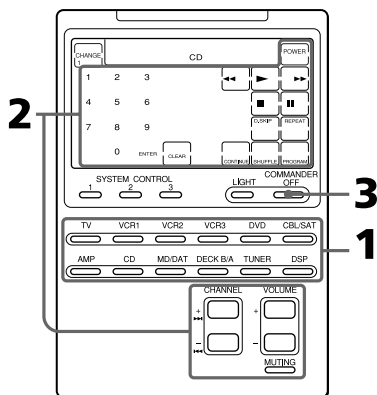

Example: To play a CD player

- 1 Press the desired Component Select button.

CD



The Commander comes on and the keys for operating the selected component are displayed.

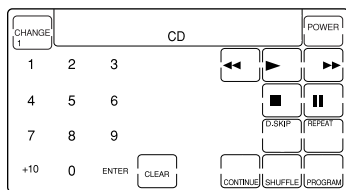

Operating Your Components with the Remote Commander (continued)

2 Press the desired key in the touch-key display.

When the remote control signal is sent,  is displayed on the display.



You may also use the VOLUME +/- buttons, the MUTING button and the CHANNEL +/- buttons if necessary. See “Table of Preset Functions” (page 58) for the functions of keys and buttons for each component.

3 When you are done using the Commander, press COMMANDER OFF to power off the Commander.

COMMANDER
OFF



Note

The remote control signals may be different for some components or functions. In this case, program the remote control signals with the learning function (see page 16). Note, however, that components and functions that do not support the remote control of infrared signals will not work with this Commander.

To control the volume

Press the VOLUME +/- buttons to control the volume, and the MUTING button to mute. When you select a visual component, the TV's volume will be controlled, and when you select an audio component, the amplifier's volume will be controlled. You can change this setting also (page 22).

Notes

- If you have programmed any signal for the VOLUME or MUTING button for any component using the learning function (page 16), that signal will be transmitted instead of controlling the volume of the TV or amplifier once you select that component.
- If you have programmed any signal for the VOLUME or MUTING button of TV or AMP using the learning function, that signal will be transmitted only after you select TV or AMP. When you select another components, the preset volume control signals for TV or AMP will be transmitted at that time.
- If you have assigned another component to the TV or AMP button (page 35), the volume of the TV or amplifier cannot be controlled even when you select other components.

Notes on operating your components

When you use a double cassette deck

You need to select deck A or B before operating. To select the deck, press DECK B/A to switch the display between "DECK A" and "DECK B".

Be sure that you have set a component code each for DECK A and DECK B (page 8).

However, if you have assigned a cassette deck to another Component Select button (page 35), you can only select either DECK A or DECK B.

About the input select of a TV

Each time the INPUT key is pressed, the input is changed in order. It is also possible to select directly as follows when you are connecting more than two VCRs.

"INPUT" + "0" : TV tuner

"INPUT" + "1" : VIDEO1

"INPUT" + "2" : VIDEO2

"INPUT" + "3" : VIDEO3

"INPUT" + "4" : VIDEO4

"INPUT" + "5" : VIDEO5

"INPUT" + "6" : VIDEO6

If the above operations do not work, program the remote control signals of your component on the Commander using the learning function (page 16).

About the input select of a VCR

Each time the INPUT key is pressed, the input is changed in order. It is also possible to select directly as follows.

"INPUT" + "0" : Tuner

"INPUT" + "1" : LINE1

"INPUT" + "2" : LINE2

"INPUT" + "3" : LINE3

"INPUT" + "4" : LINE4

"INPUT" + "5" : DV

When you use a Sony VCR, the above commands are preset. For other brands, it is possible to "teach" the above double-key operations using the learning function (see page 16).

Using Non-Preset Remote Control Operations

— Learning Function

To operate non-preset components or functions, use the following “learning” procedure to “teach” any of the programmable buttons and keys to operate the functions of another remote control. You can also use the learning function to change the signal of individual keys and buttons after setting the component code number (page 8). It is useful if you make a memo of the learned key functions in the LCD touch key display table (See page 66).

Note

Some specific remote control signals may not be learned.

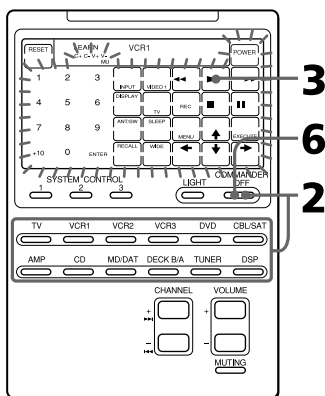

Example: To program the ► (Play) signal of your component to the VCR1 ► (Play) key of the Commander

- 1 Place the RM-AV2100 head to head with your component's remote control.

Remote control for your component

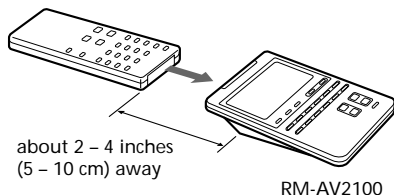

- 2 While pressing COMMANDER OFF, press the Component Select button for the component whose signals are to be learned.

COMMANDER OFF + VCR1

“LEARN” appears and all the learnable keys flash.

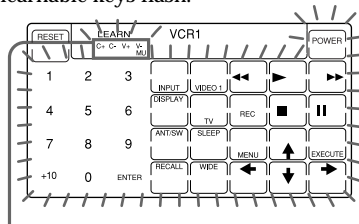

Display for CHANNEL, VOLUME and MUTING buttons

The “C+ C- V+ V- MU” display indicates if CHANNEL +/-, VOLUME +/- and MUTING buttons are learnable or not.

Note on the flashing display

The keys or buttons that are already preset for that component flash twice while those that are not preset flash once.

-
- 3** Press the key or button on the Commander you want to “teach”.



“LEARN” flashes and the only pressed key remains on the display.

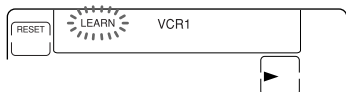

To teach on the CHANNEL +/-, VOLUME +/- or MUTING buttons
Press the corresponding button. “LEARN” flashes, and only the pressed button remains indicated on the display (“C+,” “C-,” “V+,” “V-,” or “MU”).

Example: When pressing the VOLUME + button

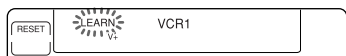

To change the function display of the key

Follow the procedure on page 19.

-
- 4** Press and hold down the button on the other remote control until you hear a beep.

(If you release the button before you hear a beep, the signal may not be learned correctly.)



“LEARN” stops flashing and stays lit. When the command has been learned successfully, the learned keys stay lit and the other learnable keys flash.

If “NG” flashes on the display
Learning did not succeed. Try Steps 3 and 4 again.

-
- 5** Repeat Steps 3 and 4 to teach functions to other keys or buttons.

To learn another component's remote control signal

After positioning the two remote commanders as in Step 1 on page 16, press the corresponding Component Select button, and then follow Steps 3 and 4 on the left to perform learning.

-
- 6** Press COMMANDER OFF.

COMMANDER
OFF



Using Non-Preset Remote Control Operations

— Learning Function(continued)

Notes

- If you do not perform learning steps within two minutes, learning mode ends.
- If you do not perform Step 4 within 10 seconds after Step 3, the display turns back to the display in Step 2. (All the learnable keys flash.) In this case, perform Step 3 again while the display is flashing.
- If “NG” appears while learning, the memory is full. To free memory, clear learned functions from keys that you do not use often (page 20). Then continue the learning steps.
- If you touch a key by mistake in step 4, while pressing the RESET key, press the mistaken key. Then repeat from Step 3 to continue learning.

If the Commander does not seem to be working

If the learned key or button does not operate properly, teach once again. (For example, if the volume becomes very loud after pressing the VOLUME+ button only once, noise may have interfered during the learning procedure.)

If you set a component code after learning a signal

If you have programmed any signal for a key or button using the learning function, that signal will remain assigned to that key or button even after you set a component code.

When you teach the signals for a double cassette deck

Press DECK B/A to select deck A or B.

When you teach the REC (record) signal

If you have to press two buttons at the same time (for example, ● and ►) to start recording on your cassette deck or VCR, teach the REC signal in one of the following ways.

To operate with two keys on the Commander

In Step 3 (page 17), while pressing the REC key, press the ► key to display both keys. Then press the two buttons on your component's remote control in Step 4.

To operate with one key on the Commander

In Step 3 (page 17), press only the REC key. Then press the two buttons on your component's remote control in Step 4.

When you teach signals to the VOLUME or MUTING buttons

- If you have programmed any signal on the VOLUME or MUTING button for components other than TV and AMP using the learning function, that signal will be transmitted only when you select that component.
- If you have programmed any signal on the VOLUME or MUTING button for TV or AMP using the learning function, that signal will be transmitted only when you select TV or AMP. When you select other components, the preset volume control signals for TV or AMP will be transmitted (for the difference between visual components and audio components, see page 22). To use the learned signal, you need to program the VOLUME or MUTING button for each component using the learning function.

When you teach the signals of an air-conditioner

See the notes on page 39.

To display only the frequently used keys

You can hide keys you do not use. This makes operations even easier to understand, when the components have many keys.

After Step 2 on page 16, while pressing the RESET key, press the key you want to hide (flashing). The pressed key changes to slower flashing and will no longer be displayed during remote control operations.

To display it again, perform the same procedure again.

Note

You can not hide a key which has "learned" any signal.

To change the function display of a key

When you program a signal for a key, you can select the most suitable function display among all the displays the key has, and set it to the key.

- 1 After Step 2 (page 16), while pressing the Component Select button (VCR1), press the key you want to teach repeatedly.

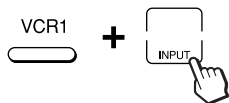

Each time the key is pressed, the display is changed in order.

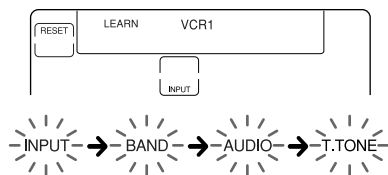

- 2 When the desired display appears, release the Component Select button.

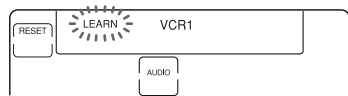

- 3 Then follow Steps 4 to 6 (page 17).

Notes

- You can change the display of a key only when you program it using the learning function. If you want to change the display of the key that has learned a signal, clear the signal first (page 20). Then teach the key again using the above procedure to change its display.
- If you don't change the display of a key, the default display is used.
- You cannot change the display of the keys that are not framed with  (the numeric keys 0 to 9, +10 and ENTER).

Using Non-Preset Remote Control Operations — Learning Function (continued)

For accurate learning

- Do not move the remote units during the learning procedure.
- Be sure to keep holding down the button of the other remote control until you hear the confirmation beep.
- Use fresh batteries in both remote control units.
- Avoid learning in places under direct sunlight or a strong fluorescent light.
- The remote control detector area may differ depending on each remote unit. If learning does not work, try changing the positions of the two remote control units.
- When you teach signals of an interactive signal exchange system remote control unit (supplied with some of Sony's receivers and amplifiers) to the Commander, the response signal of the main unit may interfere with the learning of the Commander. In such a case, move to a place where the signals will not reach the main unit (e.g. other rooms, etc.).

IMPORTANT

Be sure to place the Commander out of the reach of small children or pets. Also set the Hold function to lock the all buttons on the Commander (page 47) when it is not used. Components such as air conditioners, heaters, electric appliances, and electric shutters or curtains receiving an infrared signal can be dangerous if misused.

Changing or erasing the function of a taught key or button

To change the learned function, clear it first and perform learning again.

To clear the learned function of a single key or button

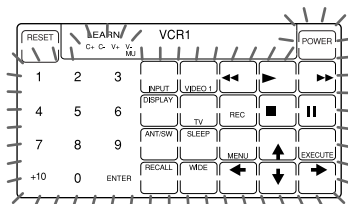

- 1 After Step 2 (page 16), while pressing the RESET key, press the key or button you want to erase.

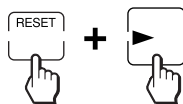

The cleared key flashes together with other learnable keys.

- 2 Press COMMANDER OFF.



To clear all signals learned for a specific component

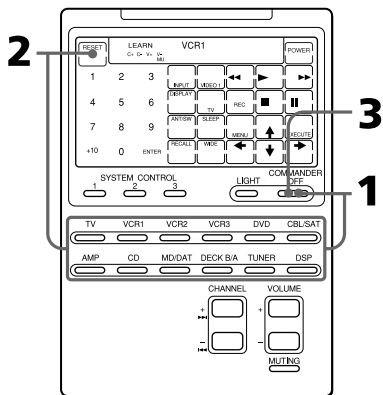

3 Press COMMANDER OFF.



Note

For DECK B/A, be sure to display the deck that has a learned signal (“DECK A” or “DECK B”) before you perform the steps above. If you reset the wrong deck, the component codes for both A and B will be reset to the factory settings (page 8).

1 While pressing COMMANDER OFF, press the corresponding Component Select button.

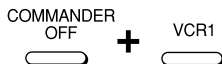

When you want to clear signals learned for DECK B/A

Press DECKB/A to display “DECK A” or “DECK B”. You can not clear both decks at the same time.

2 While pressing the RESET key, press that Component Select button again.

The learned contents are cleared. The keys for the component return to their original states before learning.

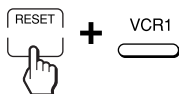

Controlling the Volume of Visual Components Connected to an Audio System

The Commander is factory preset based on the assumption that you hear the sound of your visual components from your TV speakers, and that you hear sound of your audio components from the loudspeakers connected to your amplifier.

This feature enables you to control the volume of your TV or amplifier without having to select TV or AMP each time you want to control the volume.

For example, to control the volume while using a VCR, you don't need to press the TV button to control the TV volume.

The following table shows the factory setting of which volume would be controlled for each component.

Component Select button	Controls the volume of
TV	TV
VCR1,2,3	TV
CBL/SAT	TV
DVD	TV
AMP	amplifier
CD	amplifier
MD/DAT	amplifier
DECK B/A	amplifier
TUNER	amplifier
DSP	amplifier

However, if your visual components are connected to an audio system, you probably hear TV or VCR sound from the loudspeakers via your amplifier, not from your TV speakers. In this case, you need to change the factory preset so that you can control the volume of your visual components without first having to switch to the amplifier.

To change the Factory Preset of the Volume Control

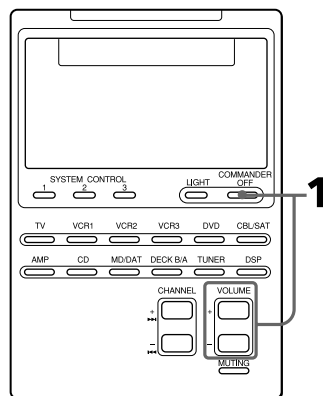

- 1 While pressing COMMANDER OFF, press VOLUME + and VOLUME -.

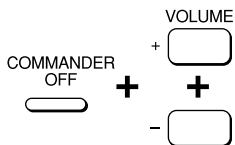

The volume control setting of visual components (TV, VCR1,2 and 3, CBL/SAT, and DVD) changes to the displayed component.

When set to amplifier volume { $V_+ V_-$ M_+ M_- AMP

When set to TV volume { $V_+ V_-$ M_+ M_- TV

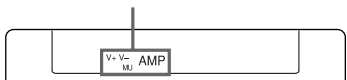

Notes

- If you have already programmed the VOLUME or MUTING button of each component any signals by “learning”, the procedure above will not change the function of the VOLUME and MUTING buttons.
- If you have programmed volume control signals on VOLUME or MUTING buttons of TV or AMP, you can only use that signal when you select TV or AMP. For other component, the preset volume control signals for TV or AMP (depending on the above setting procedure) will be transmitted. To use the new signals, you need to program each button for each component by the learning procedure (page 16).

Executing a Series of Commands

— System Control Functions

With the System Control function, you can program a series of operating commands, and execute them by pressing just one button.

For example, when you watch a video, a series of operations like the ones below are necessary.

Example:

- 1 Power on the TV.
- 2 Power on the video (VCR 1).
- 3 Power on the amplifier.
- 4 Set the input selector of the amplifier to VIDEO 1.
- 5 Set the input mode of the TV to VIDEO.
- 6 Start video playback

You can program up to 16 consecutive operation steps to each of the SYSTEM CONTROL 1, 2 or 3 buttons.

If you have set the System Control function for a Component Select button (page 28), the execution of the programmed commands begins when you press the Component Select button for more than 2 seconds.

While executing the programmed commands, at the same time that each remote control signal is transmitted, the corresponding key is displayed.

**Executing a Series of Commands
— System Control Functions
(continued)**

Programming a series of commands to the SYSTEM CONTROL buttons

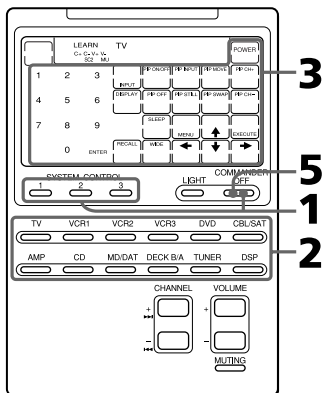

Example: To program the procedure above to the SYSTEM CONTROL 2 button

- 1 While pressing COMMANDER OFF, press one of the SYSTEM CONTROL buttons (in this case, SYSTEM CONTROL 2).

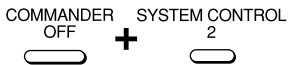

All the component names flash.

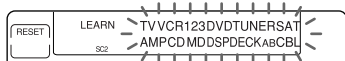

If a series of commands is already programmed for that button That program will be displayed. (At the factory, the SYSTEM CONTROL 1 button is preset with the System Power-Off function for Sony components (the same function as explained in page 34), and the SYSTEM CONTROL 3 button is factory preset with standard power-on command for nearly all Sony components.)

To program a new series of operations, clear the program first (see page 26).

- 2 Press the Component Select button for the component to operate.



The keys for the selected component flash.

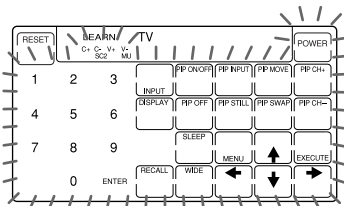

If the component has the power-on and power-off signals

Both the OFF and ON keys are displayed and you can select either of them to program.

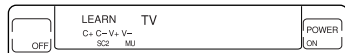

It is useful to set the exact command for power-on or power-off and operate the component regardless of its status (on/off).

3 Press key(s) or button(s) for the desired operation.



If you want to power on the TV, press the POWER (or POWER ON) key.

4 Repeat Steps 2 and 3 and program the buttons and keys for the series of operations.

In this example, press the following buttons and keys.

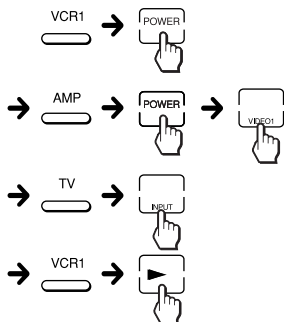

5 When you have programmed all the keys, press COMMANDER OFF.



Notes

- If you interrupt the procedure at any point for over two minutes, the setting mode ends and the series of commands will be programmed to that point. In this case, clear the program (page 26) and start again from Step 1 to set the entire program from the beginning. You cannot continue from where you let off.
- If a SYSTEM CONTROL button has already “learned” a remote control signal (see page 38), “NG” flashes and you cannot program on this button. Clear the learned contents first (see page 40).
- If you change the component code number (page 8) or program a new signal by learning (page 16) on a key or button that has been programmed in the series of commands of the System Control function, the new signal will be transmitted when you press the corresponding SYSTEM CONTROL button.
- During Setting mode, the RESET key is not displayed and you cannot clear any operation step you have programmed. If you have programmed an incorrect operation by mistake, start again from Step 1.

Tips for programming the System Control functions

The following information helps you to program a consecutive operation steps.

About the interval between operation steps

You can change the interval between operation steps (see page 30).

Executing a Series of Commands — System Control Functions (continued)

About the order of operation steps

- Some of the components may not accept consecutive remote control signals. For example, a TV generally does not react to next signal right after the Power-on signal. So, a series of commands such as TV Power-on and input select may not work properly. In this case, insert other signals like the example below;

TV Power-on → VCR Power-on
→ VCR play back → TV input select

- After the series of input commands is executed, the Commander displays the touch-keys of the component of the final step. By programming an often-used component's command as the final step, you can save the step of pressing a Component Select button when you start operating that component. (In the example on page 24, the touch-keys of VCR1 are displayed.)

To clear programmed commands

- 1 While pressing COMMANDER OFF, press one of the SYSTEM CONTROL 1, 2, or 3 button.

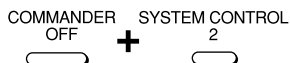

The key operations programmed for that button are displayed in order.

- 2 While pressing the RESET key, press the same SYSTEM CONTROL button (1, 2, or 3) again.

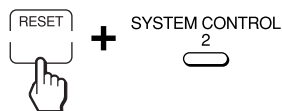

When the contents of its program are cleared, all the component names flash.

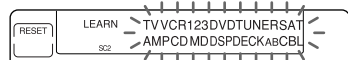

When you want to set a new program to this SYSTEM CONTROL button, follow Steps 2 to 5 on pages 24 and 25.

To set the SYSTEM CONTROL 1 or 3 button back to the factory setting

At the factory, the SYSTEM CONTROL 1 button is preset with a series of power-off commands for Sony components and the SYSTEM CONTROL 3 button with a series of power-on commands for Sony components. To reset them to the factory settings, follow the steps below.

-
- 1** While pressing COMMANDER OFF, press the SYSTEM CONTROL button (1 or 3).

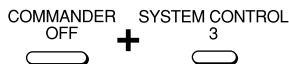

The programmed key operations are displayed in order.

- 2** While pressing the RESET key, press the SYSTEM CONTROL button (1 or 3).

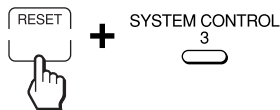

When the contents of its program are cleared, all the components names flash.

- 3** While pressing the RESET key, press the SYSTEM CONTROL button (1 or 3) again.

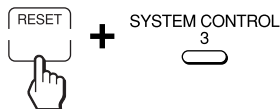

When it is reset to the factory setting, the programmed operations are displayed in order.

Note

The interval setting (page 30) is not reset to the factory setting, even if you perform these steps.

Notes on System Control Operations

- If the remote control detectors of the components are too far apart, or if something is blocking them, some of the components may not operate consecutively even after you press the SYSTEM CONTROL button.
- If some of the components did not operate correctly because of the above or for any other reason, always set all the components back to the states they were in before you pressed the SYSTEM CONTROL button. Failure to do this can result in incorrect operation when you press the SYSTEM CONTROL button again.
- Some components may not always be powered on by the System Control function. This is because the power of the component gets on and off alternatively when receiving the power on/off signal. In this case, check the operating component's power on/off state before using the system control function.
- If the system control function does not work correctly, see also "Tips for programming the System Control functions" on page 25.

**Executing a Series of Commands
— System Control Functions
(continued)**

Programming a series of commands to the Component Select buttons

As with the SYSTEM CONTROL buttons, you can also program a series of operating commands for the Component Select buttons (up to 16 steps).

To execute the commands programmed on a Component Select button by the System Control function, press the button for more than 2 seconds.

Notes

- The programmed commands are executed when you press a Component Select button for more than 2 seconds. When you press the button for less than 2 seconds, it works as the normal Component Select button, and the corresponding touch-keys are displayed.
- See also “Tips for programming the System Control functions” on page 25 and “Notes on System Control Operations” on page 27.

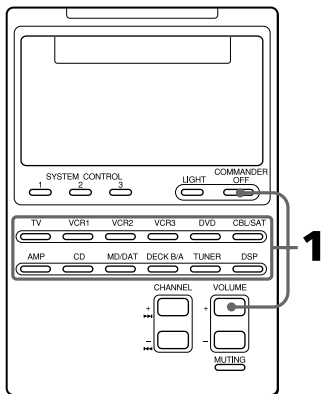

Example: To program the procedure on page 23 for the VCR3 button

- 1 While pressing COMMANDER OFF, press VOLUME+ and VCR3.

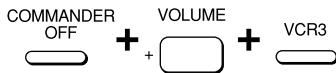

All the component names flash.

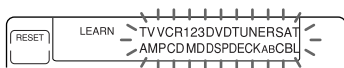

If a series of commands is already programmed for that button

The programmed operations are displayed in order. To program a new series of operations, clear the program first (page 29).

- 2 Follow Steps 2 to 5 on pages 24 and 25.
-

Notes

- You can program the System Control functions for a Component Select button on which the Power-On function (page 31) has been programmed. In this case, the Power-On function is overwritten and cannot be used. If you clear the System Control functions for the button, the Power-On function is resumed, and you can use it again.
- You cannot program the System Control functions for a Component Select button for which a signal has been programmed by “learning” (page 32). (“NG” flashes on the display.)
- You can program a signal for a Component Select button by “learning” (page 32) for which the System Control functions have been programmed. In this case, the System Control function is overwritten and cannot be used. If you clear the “learned” signal on the button, the System Control function is resumed and you can use it again.
- You can program the Power-On function (page 31) for a Component Select button for which a System Control function has been programmed, but the Power-On function cannot be used. If you clear the System Control function from the button, you can use the Power-On function.
- If you interrupt the procedure at any point for over two minutes, the setting mode ends and the series of commands will be programmed to that point. In this case, clear the program and start again from Step 1 to set the entire program from the beginning. You can not continue from where you let off.
- If you change the component code number (page 8) or program a new signal by learning (page 16) for a key or button that has been programmed with the series of commands of a System Control function, the new signal will be transmitted when you press the corresponding Component Select button.

To clear a System Control function programmed for a Components Select buttons

Example: To clear the programmed commands on the VCR3 button

- 1 While pressing COMMANDER OFF, press VOLUME+ and VCR3.

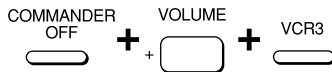

- 2 While pressing the RESET key, press VCR3.

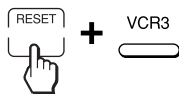

When the contents of its program are cleared, all the component names flash.

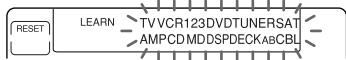

When you want to set a new program to this Component Select button, follow Steps 1 to 2 on page 28.

Executing a Series of Commands
— System Control Functions
(continued)

Changing the interval between operation steps

You can control the interval in 4 steps (approx. 127 ms, 408 ms, 708 ms, 974 ms).

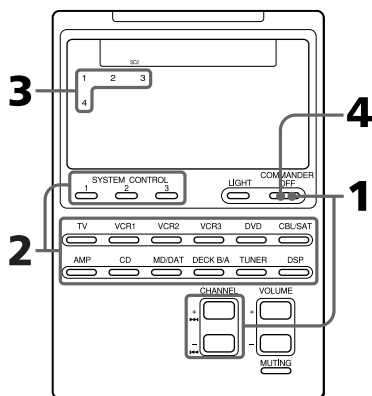

- 1** While pressing **COMMANDER OFF**, press **CHANNEL+** and **CHANNEL-**.

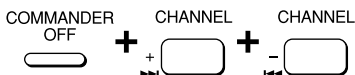

“SC1,” “SC2,” “SC3” and all the component names flash.

Display for the SYSTEM CONTROL Component names
 1, 2, 3 buttons



- 2** Press one of the **SYSTEM CONTROL** buttons (1, 2, or 3) or the **Component Select** button whose interval you want to change.

SYSTEM CONTROL



The number of the current setting stays lit and other numbers flash.



- 3** Press one of the numeric keys (1 – 4) to select the interval.

- 1: approx. 127 ms (factory setting)
- 2: approx. 408 ms
- 3: approx. 708 ms
- 4: approx. 974 ms

(ms: 1/1000 second)



The selected number stays lit and other numbers flash.

- 4** Press **COMMANDER OFF**.

COMMANDER OFF



Adding an Extra Function to the Component Select Buttons

Programming the Power-On command of the selected component (for Sony components only)

When using Sony components, you can program the Power-on signal for each component on a Component Select button. You can select the desired component and power it on by just pressing that Component Select button.

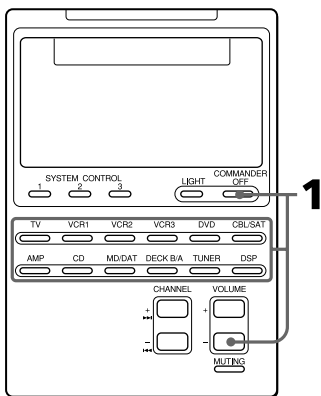

Example: To program the TV button

- 1 While pressing COMMANDER OFF, press VOLUME - and the desired Component Select button.



When the Power-on command is programmed, you will hear a beep and “POWER ON” appears on the display. (The display goes off when you release the buttons.)



To clear the Power-on command

Repeat the procedure above.
The following display appears.



Adding an Extra Function to the Component Select Buttons (continued)

Notes

- If the component code of a non-Sony product has been set for a Component Select button, you cannot program the Power-On function for it.
- Even if you have programmed a signal by “learning” (See “Adding a command that is required when selecting a component.”) or a System Control function (page 28) for a Component Select button, you can program the Power-On function for that button, but it cannot be used. If you clear a “learned” signal or the System Control function from the button, you can use the Power-On function.
- You can program a signal by “learning” (page 32) or a System Control function (page 28) for a Component Select button for which the Power-On function has been programmed. In this case, the Power-On function is overwritten and cannot be used. If you clear the “learned” signal or the System Control function from the button, the Power-On function is resumed, and you can use it again. If you have programmed both a signal by “learning” and a System Control function for the button, the “learned” signal will have overwritten the System Control function.

Adding a command that is required when selecting a component

In addition to the original function of selecting the operating keys and buttons of the desired component, the Component Select button can have another remote control signal by “learning.”

For example, if you always have to change input select of the amplifier to CD when listening to the CD player, program the signal of “changing the amplifier’s input select” to the CD button of this Commander. Then whenever you press the CD button, it automatically works as the original CD Component Select button and changes also the amplifier input select to CD. (In this case, the amplifier should be turned on first.)

Note

Some specific remote control signals may not be learned.

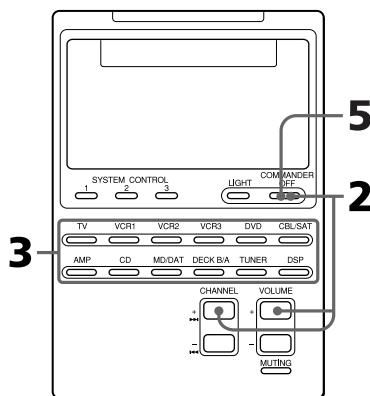

Example : To program the input select signal of your amplifier to the CD button

- 1 Place the RM-AV2100 head to head with your component's remote control.

Remote control of your component

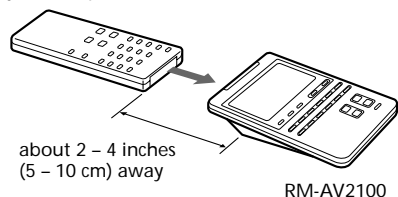

- 2 While pressing COMMANDER OFF, press CHANNEL + and VOLUME +.

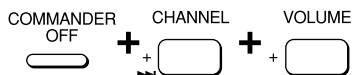

"LEARN" appears and all the component names flash.

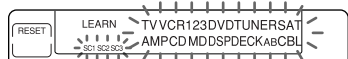

Note

The name of a Component Select button for which a signal has already been learned stays lit. If you want to program a new signal for that button by learning, clear the learned signal first (page 34).

- 3 Press the desired Component Select button.

CD



The selected component name stays lit and "LEARN" flashes.



- 4 Press and hold down the button on the component's remote control (amplifier in this example) until you hear a beep. (If you release the button before you hear a beep, the signal may not be learned correctly.)

INPUT SELECT



"LEARN" stops flashing and stays lit.

If "NG" flashes on the display
Learning did not succeed. Try Steps 3 and 4 again.

- 5 Press COMMANDER OFF.

COMMANDER OFF



Adding an Extra Function to the Component Select Buttons (continued)

To clear the learned function of the Component Select button

- 1 While pressing COMMANDER OFF, press CHANNEL+ and VOLUME+.
- 2 While pressing the RESET key, press the Component Select button which you want to clear.

Notes

- You can program a signal by “learning” for a Component Select button for which a System Control function (page 28) or the Power-On function (page 31) has been programmed. In this case, the System Control function or the Power-On function is overwritten and cannot be used. If you clear the “learned” signal from the button, the System Control function or the Power-On function is resumed, and you can use it again.
- You cannot program a System Control function (page 28) for a Component Select button for which a signal has been programmed by “learning.”
- You can program the Power-On function for a Component Select button for which a signal has been programmed by “learning,” but then the Power-On function cannot be used. If you clear a “learned” signal from the button, you can use the Power-On function.

Turning Off the Power of All Components with the Touch of a Single Button

— System Power-Off Function (for Sony Components only)

When the System Power-Off function is active, you can turn off all Sony components just by pressing the COMMANDER OFF button for three seconds.

Notes

- Some Sony components may not be turned off with this function.
- The power-off signals are transmitted at intervals that are set for the System Control function set for the SYSTEM CONTROL 1 button (page 30). If you change the interval for the SYSTEM CONTROL 1 button, the interval of the System Power-Off function is also changed.

To set the System Power-Off function

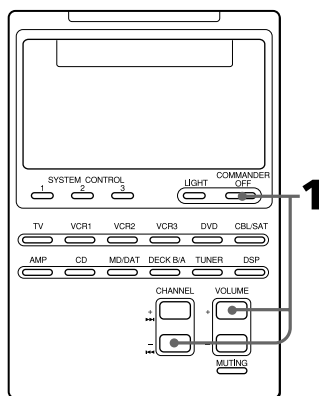

- 1 While pressing COMMANDER OFF, press CHANNEL - and VOLUME +.

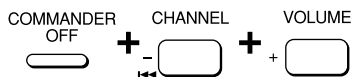

When the System Power-Off function is set, "POWER OFF" appears on the display. (The display goes off when you release the buttons.)



To cancel the System Power-Off function

Repeat the procedure above. The following display appears when the System Power-Off function is disabled.



Assigning Other Components to the Component Select Buttons

You can assign another component to any Component Select button. For example, if you have two VCRs and two CD players, you can use the VCR3 button as the Component Select button for your second CD player.

Notes

- Once you assign another component to a Component Select button, the setting of the component code number will be erased. The component code number will not return even if you reset the newly assigned component and turn back to the original component.
- If you have assigned another components to the TV or AMP button, the volume of the TV or amplifier cannot be controlled (page 14, 22) even when you select another component.
- If you use the DECK B/A button, deck B is always selected.

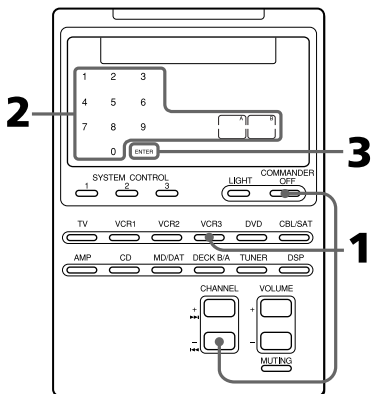

Assigning Other Components to the Component Select Buttons (continued)

Example: To assign a CD player to the VCR3 button

- 1 While pressing COMMANDER OFF, press CHANNEL- and VCR3.

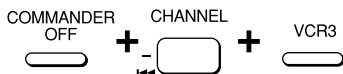

The number 0 - 9, "A", "B" and "ENTER" flash.

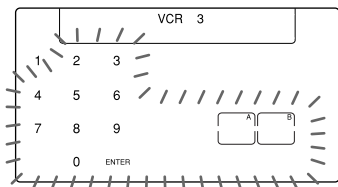

- 2 Press one of the following keys to select a new component to assign.

In this example, press the 5 key to select CD.

- | | |
|---------|----------|
| 1: VCR | 7: MD |
| 2: VD | 8: TV |
| 3: SAT | 9: CBL |
| 4: AMP | 0: DVD |
| 5: CD | A: TUNER |
| 6: DECK | B: DSP |



- 3 Press the ENTER key.



"VCR3" (the original component), "CD" (the new component) and "ENTER" appear twice.



- 4
- If the newly assigned component is a Sony component, press COMMANDER OFF to finish this procedure.
 - If you need to set the component code, follow the steps on pages 8 and 9.
 - If you need to program some signals by the "learning" function, follow the Steps 1 to 6 on pages 16 and 17.

Note

If "NG" flashes on the display when you press the Component Select button at Step 1, you can not assign another component because some of the keys or buttons are already programmed with the learning function (see page 32). Try the above procedure again after clearing the learned signals for that component.

To use the Commander after assigning other components

Press the reassigned Component Select button. The keys of the new component are displayed and you can use the desired component. Note however that only the original component name is displayed.

(In this example, the display would be like the one below.)

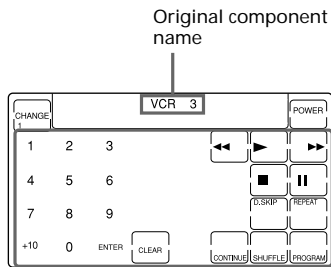

To reset a Component Select button to its original setting

- 1 While pressing COMMANDER OFF, press the Component Select button which you want to reset.
- 2 While pressing the RESET key, press that Component Select button again. The setting for that Component Select button returns to the factory setting.
- 3 Press COMMANDER OFF.

Note

If you have programmed some signals on any of the keys or buttons with the learning function (see page 16) after you reassigned your component, the two steps above only clears the "learned" signals. In this case, perform Step 2 again to reset to the original Component Select button.

Copying the settings of a Component Select button to another button

You can copy the entire settings of a Component Select button to another Component Select button. The settings of the component code (page 8), the channel macro function (page 45), and the learned functions (page 16) are copied to a new button.

Note

You cannot copy the settings to a Component Select button for which any learning function or channel macro function has been programmed. ("NG" flashes.)

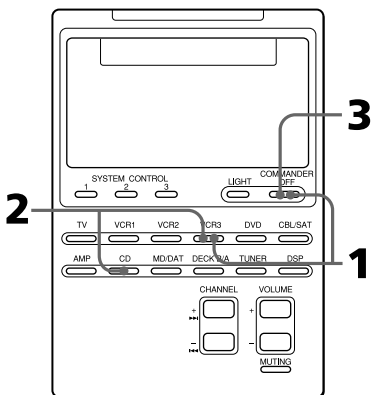

Assigning Other Components to the Component Select Buttons (continued)

Example: To copy the settings of the CD button to the VCR3 button

- 1 While pressing COMMANDER OFF, press VCR3.

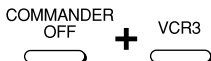

The keys for that component (VCR3) flash.

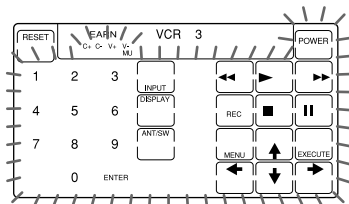

- 2 While pressing VCR3, press CD.



The keys for CD flash.

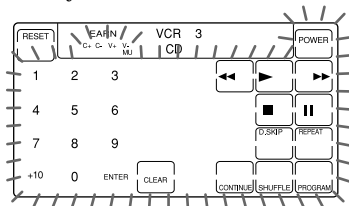

- 3 Press COMMANDER OFF.



Programming a Frequently Used Key Operation for SYSTEM CONTROL Buttons

In addition to their original System Control functions (see page 23), SYSTEM CONTROL 1, 2 or 3 buttons can be programmed to “learn” any remote control signal.

As they operate independently from other buttons, SYSTEM CONTROL 1, 2 or 3 buttons can work as one-touch buttons without any preceding operation such as pressing a Component Select button to select a component.

This is useful if you prefer having the SYSTEM CONTROL button as a “one-touch” button for a single operation rather than executing a series of commands.

Note

Some specific remote control signals may not be learned. Refer to the operating instructions supplied to the specific remote control as well.

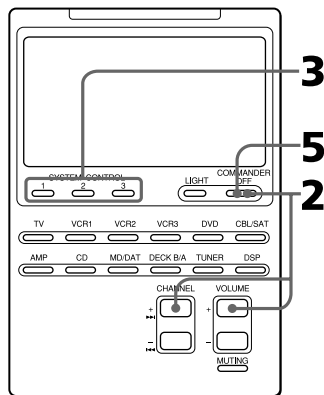

Example: To store the On/Off signal of an air-conditioner to the SYSTEM CONTROL 2 button

- 1** Place the Commander head to head with the remote control of the air-conditioner.

Remote control of your air-conditioner

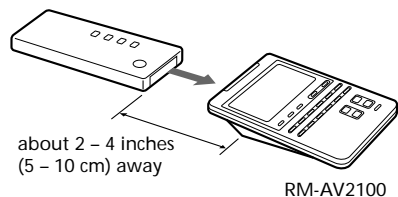

- 2** While pressing COMMANDER OFF, press CHANNEL + and VOLUME +.

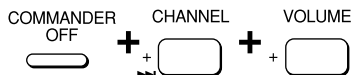

“LEARN” appears and the display that stands for the learnable SYSTEM CONTROL buttons flashes in the display panel.

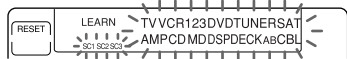

If a signal has been learned on that button, the display stays lit. If you want to program on that button, clear the signal first (page 40).

- 3** Press the SYSTEM CONTROL button you want to teach.

SYSTEM CONTROL



“LEARN” flashes and the display for the pressed SYSTEM CONTROL button stays lit.

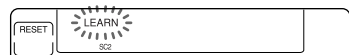

- 4** Press and hold down the button of the remote control until you hear a beep.

(If you release the button before you hear a beep, the signal may not be learned correctly.)

AIR CONDITIONER



“LEARN” display stops flashing and stays lit.

If “NG” flashes on the display
Learning did not succeed. Try Steps 3 and 4 again.

- 5** Press COMMANDER OFF.

COMMANDER OFF



Programming a Frequently Used Key Operation for SYSTEM CONTROL Buttons (continued)

Note

You can program a remote control signal for a SYSTEM CONTROL button by “learning” for which the System Control functions have been programmed. In this case, the System Control functions are overwritten and cannot be used. If you clear the “learned” signal from the button, the System Control function, are restored, and you can use them again.

To clear the learned remote control signal

- 1 While pressing COMMANDER OFF, press CHANNEL+ and VOLUME +.
- 2 While pressing the RESET key, press the SYSTEM CONTROL button (1, 2, or 3).
- 3 Press COMMANDER OFF.

The display for that button flashes.

If you want to program a new signal for that button, follow Steps 3 to 5.

Notes on learning the signals of an air-conditioner

About seasonal adjustments

If you change the settings of the air-conditioner for the season, you have to program the remote control signals of the new settings on the Commander.

If the power-on/off operation does not work correctly

The air-conditioner may not be turned on or off properly with the button of this Commander, for which you have programmed its power-on/off signal. If the Commander can operate only “ON” with one button and “OFF” with another, while your air-conditioner’s remote control can operate “ON/OFF” with a single button, program the signal on two buttons of the Commander as follows.

- 1 Clear the learned power-on/off signal. (In the example on page 39, clear the learned signal from the SYSTEM CONTROL 2 button.)
- 2 Program the signal (transmitted from the power-on/off button of the air-conditioner’s remote control) for the SYSTEM CONTROL 2 button again.
- 3 Program the signal from the same button of the remote control for another button (for example, the SYSTEM CONTROL 3 button).

The two buttons of the Commander have been programmed with the power-on signal and the power-off signal of the air-conditioner, respectively so that you can operate the air-conditioner with the Commander.

Transferring Data between Remote Commanders

You can transfer data, such as learned signals and component code settings, between this Commander and another Sony RM-AV2100 or a Sony RM-VL900 remote commander.

Note on remote commanders

You can transfer data between remote commanders with the  mark. Other remote controls cannot be used to transfer data.

Transferring data

You can transfer the all data of this Commander or the data of a Component Select button on this Commander to another Sony RM-AV2100 or RM-VL900.

To transfer the all data of the Commander

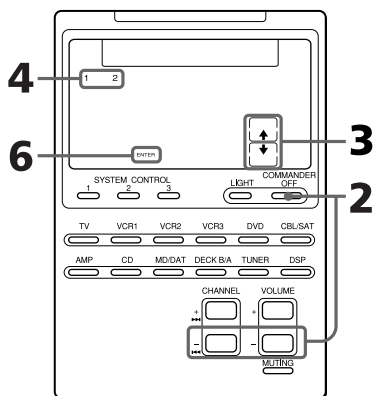

- 1 Place the RM-AV2100 head to head with another remote commander.

Another remote commander

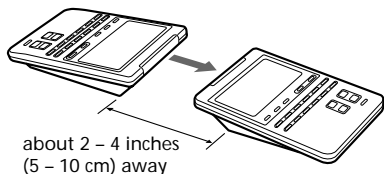

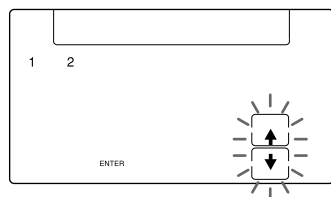
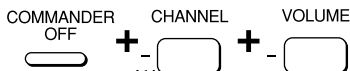

RM-AV2100

- 2 While pressing COMMANDER OFF, press CHANNEL- and VOLUME-.



- 3 Press the  key.



: Transfer data
: Receive data

Transferring Data between Remote Commanders (continued)

4 Press the 1 key.



- 1: All data of the Commander
 - 2: Data of a Component Select button
-

5 Confirm that the receiving remote commander is ready for data. (To set the receiving commander, follow the procedure on page 43.)

6 Press the “ENTER” key.



As the data is transferred, the corresponding component name goes off. If the all data has been successfully transferred, the backlight of the display turns off.

Note

If “NG” appears while sending the data, go back to Step 5 and continue the operation or press COMMANDER OFF to stop the operation.

Notes

- The data of the functions or keys that are not available with RM-VL900 cannot be transferred. The data of a SYSTEM CONTROL button cannot be transferred to another kind of the Commander even if the Commander has the  mark.
- Be sure that the receiving remote commander is ready to receive data.

To transfer the data of a Component Select button

The data of a Component Select button on this Commander (the settings and learned signals programmed on the keys and buttons) can be transferred to a Component Select button on another Sony RM-AV2100 or RM-VL900.

1~3 Perform Steps 1 to 3 on page 41.

4 Press the 2 key.



5 Press the Component Select button whose data you want to send.

TV



6 Confirm that the receiving remote commander is ready to accept data.

(To set the receiving commander, follow the procedure on page 43.)

7 Press the “ENTER” key.



When the data has been transferred, “TV” and “↑” go off. If the data have been successfully transferred, the backlight of the display turns off.

Note

If “NG” appears while sending the data, go back to Step 6 and continue the operation or press COMMANDER OFF to stop the operation.

Notes

- The data of the “learned” signal and the System Control function programmed for a Component Select button cannot be transferred. You can use the learning function (page 32) to program the “learned” signal and the System Control functions programmed for a Component Select button on another remote commander.
- Be sure that the receiving remote commander is ready to receive data.

Receiving the data

This Commander can receive the data of another Sony RM-AV2100 or RM-VL900.

To receive the all data from another remote commander

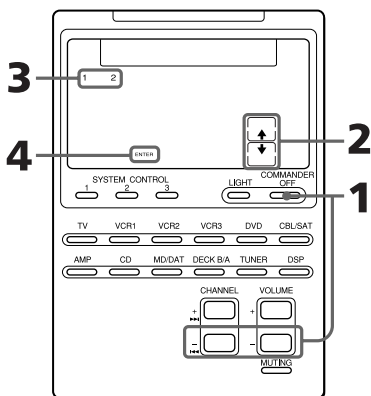

1 While pressing COMMANDER OFF, press CHANNEL - and VOLUME -.

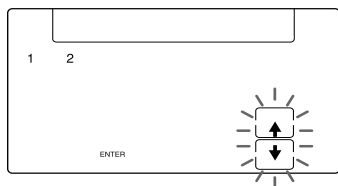
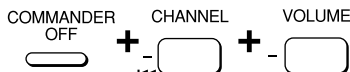

Transferring Data between Remote Commanders (continued)

2 Press the ↓ key.



↑: Transfer data
↓: Receive data

3 Press the 1 key.



1: All data of the Commander
2: Data of a Component Select button

4 Press the ENTER key.



As the data is received, the corresponding component name stays lit. If the all data have been successfully received, the backlight of the display turns off.

Notes

- If the Commander is not ready for receiving the data, press CLEAR key, then EXECUTE key to clear the learned signal on all or one of the Component Select buttons.
 - If “NG” appears during data transfer, go back to Step 3 and continue the operation or press COMMANDER OFF to stop the operation. If you continue the operation, you have to set the sending remote commander again to send data.
-

To receive the data of a Component Select button from another remote commander

1~2 Perform Steps 1 and 2 on pages 43 and 44.

3 Press the 2 key.



4 Press the Component Select button to which want to assign the data.



5 Press the ENTER key.



When the data have been received, “TV” and “↓” go off. If the data have been successfully received, the backlight of the display turns off.

Notes

- If the Commander is not ready for receiving the data, press CLEAR key, then EXECUTE key to clear the learned signal on all or one of the Component Select buttons.
 - If “NG” appears during data transfer, go back to Step 3 and continue the operation or press COMMANDER OFF to stop the operation. If you continue the operation, you have to set the sending remote commander again to send data.
-

Selecting a Channel with a Single Key Press

— Channel Macro Function

You can program the Channel Macro function for the keys listed below (macro keys).

If you program the operation of entering the 1, 2, 3 and ENTER keys for a macro key, you can select the channel 123 by pressing that single key.

Component Macro key
 TV: PIP INPUT, PIP MOVE, PIP CH+, PIP STILL, PIP SWAP, PIP CH-

CBL: ◀◀, ▶▶, ▶▶▶, REC, * ■, ||

SAT: ◀◀, ▶▶, ▶▶▶, ■, ||

* You can program this function for REC key alone (not on the REC + ▶ key for a double-key operation).

Example: To program TV channel 123 for the PIP INPUT key

- 1 While pressing COMMANDER OFF, press MUTING.

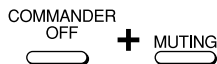

- 2 While pressing CHANNEL+, press the Component Select button (TV).

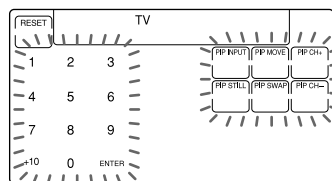

- 3 While pressing the macro key (PIP INPUT), press the keys for the operation in order (1 → 2 → 3 → ENTER).

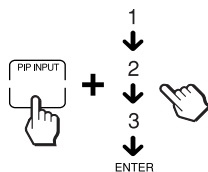

Note

If you enter more than four keys, the last four keys are programmed for the macro key.

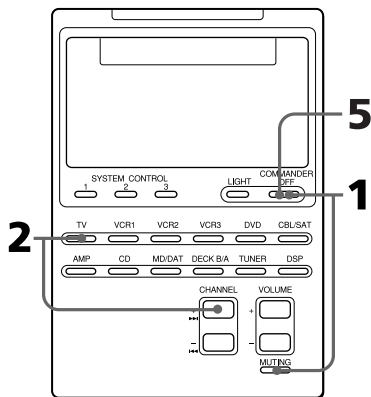

Selecting a Channel with a Single Key Press

— Channel Macro Function

(continued)

- 4** Release the macro key (PIP INPUT).
“PIP INPUT,” “1,” “2,” “3,” and “ENTER” appear twice.

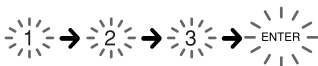

- 5** Press COMMANDER OFF.

COMMANDER
OFF



Notes

- You cannot program the Channel Macro function for a macro key that has “learned” a signal. Try again with another macro key, or clear the “learned” signal (page 20) from the button and program the Channel Macro function on it.
- If you change the component code for a key that has been programmed with the Channel Macro function, the new signal is transmitted when you press the corresponding macro key.

To clear the Channel Macro function

- 1 While pressing COMMANDER OFF, press MUTING.
- 2 While pressing CHANNEL+, press the Component Select button (TV).
- 3 While pressing the RESET key, press the macro key.

Note

The procedure above can clear only the Channel Macro function from the key. It doesn't clear the learned signals from that key.

Locking the Controls

— Hold Function

To prevent accidental operation, you can lock all the buttons with the Hold function.

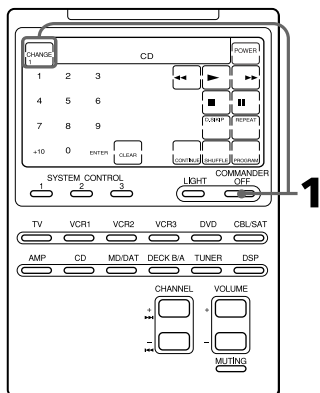

If the CHANGE key is not displayed, press any button (except the SYSTEM CONTROL or COMMANDER OFF buttons) before you start.

- 1 While pressing the CHANGE key, press COMMANDER OFF.

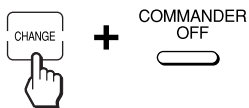

“OFF” is displayed.

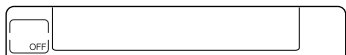

To unlock the control

While pressing the OFF key, press COMMANDER OFF.

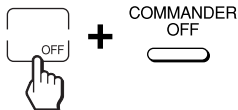

“OFF” disappears from the display.

Protecting your settings

— Preset Lock Function

You can lock the Commander so that you can not change, add, or clear any of your component code settings (page 8).

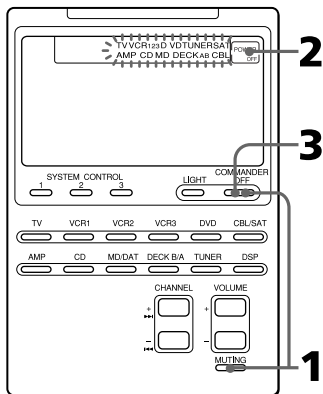

- 1 While pressing COMMANDER OFF, press MUTING.



All the component names flash and “POWER OFF” appears.

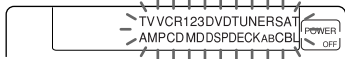

- 2 Press the POWER OFF key.



All the component names stop flashing and stay lit, and “POWER ON” flashes.

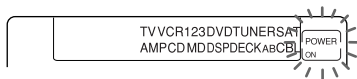

- 3 Press COMMANDER OFF.



When the preset lock is on

If you try to set a component code number (page 8) or perform learning for the Component Select buttons (page 32), “NG” will flash on the display.

To unlock the preset lock

To unlock the preset lock, follow the same procedure as the above and press the POWER ON key in Step 2. “POWER OFF” appears on the display.

Changing the Auto Power-Off Time of the Commander

The Commander is preset at the factory to switch the power off automatically after 10 minutes if left unused (Auto Power-Off). To change this time, perform the following procedure.

You can set the Auto Power-Off time up to 90 minutes, in units of 10 minutes, or disable the Auto Power-Off function.

Note

The Auto Power-Off function only turns off the power of the Commander, but not of the component.

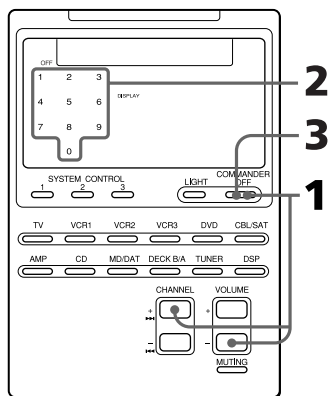

- 1 While pressing **COMMANDER OFF**, press **CHANNEL +** and **VOLUME -**.

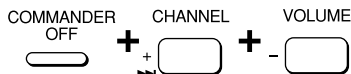

The number which shows the current Power-Off time of the Commander stays lit, and other numbers flash.

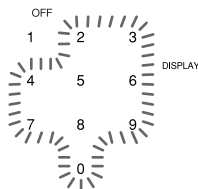

- 2 Press one of the 1 – 9 keys to select the Auto Power-Off time, or press the 0 key to disable the Auto Power-off function.

For example, to set the Auto Power-Off time to 20 minutes, press the 2 key.



“2” stops flashing and stays lit.

- 3 Press **COMMANDER OFF**.



Adjusting the Backlight of the Display Window

The Commander is preset at the factory to bright backlight, and to switch off the backlight automatically if you do not operate for more than 10 seconds. To change this setting, perform the following procedure.

You can adjust the backlight Automatic-Off time (from 10 seconds to 90 seconds in the units of 10 seconds) and the brightness (bright or dim).

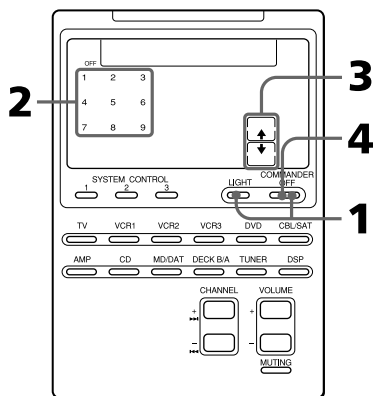

- 1** While pressing COMMANDER OFF, press LIGHT.

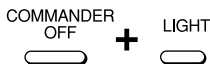

The number which shows current Automatic-Off time and the arrow indicating the current brightness of the backlight stay lit. Other numbers and the opposite arrow will flash.

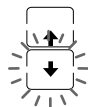
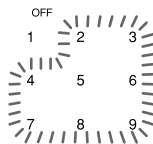

- 2** Press one of the 1 – 9 keys to select the Off time.

For example, to set the Automatic-Off time to 20 seconds, press the 2 key.



“2 “ stops flashing and stays lit.

- 3** Press the **↑** or **↓** key, to select the brightness.

To brighten, press **↑**, to dim, press **↓**.



The chosen arrow stays lit.

- 4** Press COMMANDER OFF.



Setting the Key-Touch Beep

You can turn on or off the key-touch confirmation beep.

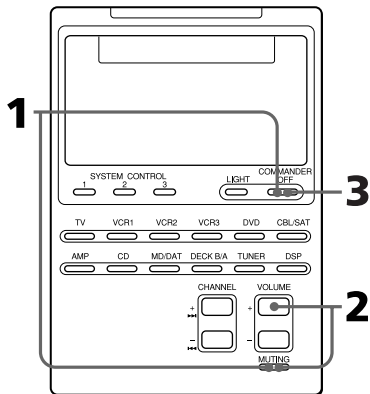

To turn on the key-touch beep

- 1 While pressing COMMANDER OFF, press MUTING.

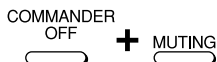

- 2 While pressing MUTING, press VOLUME+.

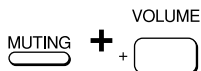

“ON” appears on the display.

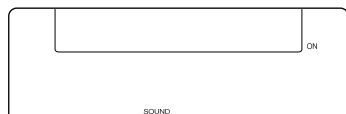

- 3 Press COMMANDER OFF.



To turn off the key-touch beep
In Step 2, while pressing MUTING, press VOLUME-.

“OFF” appears on the display.

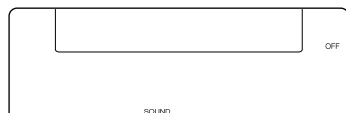

Changing the Touch-Key Display

Each Component Select button has two types of touch-key displays: the full-function display and the basic-function display. On the basic-function display, only the keys that are used for basic operations are displayed.

You can modify the basic-function display by setting only the desired keys on it (See “To display only the desired keys.”).

To change the display type

- 1 Press the CHANGE key for any Component Select key.

Each time you press the CHANGE key, the display type changes.

“CHANGE 1” appears when the full-function display is selected.

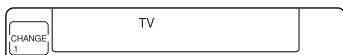

“CHANGE 2” appears when the basic-function display is selected.

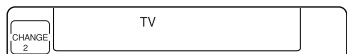

Notes

- You can select only one of the display types for all Component Select buttons. If you change the display type to the basic-function (“CHANGE 2”) display for a Component Select button, the displays for all other Component Select buttons are also changed to the same type (“CHANGE 2”).
- The number of keys displayed on the full-function display varies according to the component codes preset for the Component Select buttons. For components that have few keys in the full-function display, the basic-function display can be the same as the full one. In this case, you cannot modify the basic-function display (See “To display only the desired keys.”).
- A key that has learned any signal is always displayed both in the full- and basic-function displays.

To display only the desired keys

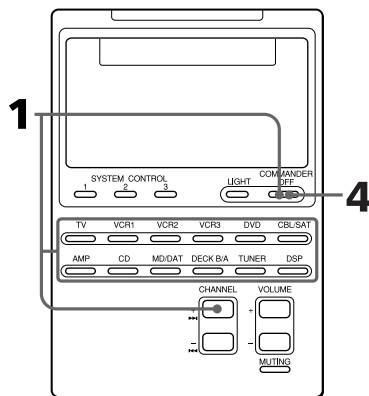

You can set only the desired keys on the basic-function display. It makes operations easier, because only the keys you will use are displayed.

-
- 1** While pressing COMMANDER OFF, press CHANNEL+ and the Component Select button whose display you want to modify.

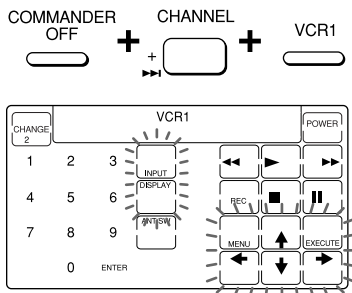

-
- 2** Press the key you want to display.

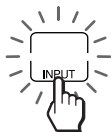

Each time the key is pressed, it is selected and deleted alternately. A selected key stops flashing and stays lit.

-
- 3** Repeat Step 2 until all necessary keys are set.

-
- 4** Press COMMANDER OFF.



Note

For components that have few keys on the full-function display, the basic-function display can be the same as the full one. In this case, you cannot modify the basic-function display.

To clear the settings on the basic-function display

- 1** While pressing COMMANDER OFF, press CHANNEL+ and a Component Select button.

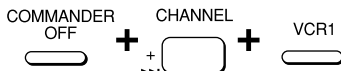

-
- 2** While pressing the CHANGE key, press the Component Select button again.



-
- 3** Press COMMANDER OFF.



Note

If you clear the settings on the basic-function display using the procedure above, the display returns to its original key settings. It doesn't clear the learned signals from keys.

Precautions

- Do not drop the unit or give a shock to the unit, or it may cause a malfunction.
- Do not leave the unit in a location near heat sources, or in a place subject to direct sunlight, excessive dust or sand, moisture, rain or mechanical shock.
- Do not put foreign objects into the unit. Should any liquid or solid object fall into the unit, have it checked by qualified personnel before operating the unit any further.
- Do not expose the remote control detectors of your components to direct sunlight or other strong illumination. Too much light there can interfere with remote control operations.
- Be sure to place the Commander out of the reach of small children or pets. Components such as air conditioners, heaters, electric appliances, and electric shutters or curtains receiving an infrared signal can be dangerous if misused.

Maintenance

Clean the surface with a soft cloth slightly moistened with water or a mild detergent solution. Do not use any type of solvent such as alcohol, benzene or thinner as they may damage the finish of the surface.

Specifications

Operating distance

Approx. 32.8 ft. (10 meters) (varies depending on components of different manufacturers)

Power requirements

Remote control and backlight: Four size AA (R6) batteries

Battery life

Approx. 5 months (varies depending on frequency of use)

Dimensions

Approx. $4\frac{3}{4} \times 7 \times 1\frac{13}{16}$ in. (w × h × d)
(120 × 175 × 45 mm)

Mass

10.22 oz. (290 g) (not including batteries)

Design and specifications are subject to change without notice.



The CE mark on the unit is valid only for products marketed in the European Union.

Troubleshooting

If you have problems setting up or using the Remote Commander, first check the batteries (page 6), then check the items below.

Symptom	Remedy
You cannot operate the components.	<ul style="list-style-type: none">• Go closer to the component. The maximum operating distance is approximately 32.8 ft. (10 m).• Check that you are aiming the Commander directly at the component, and that there are no obstructions between the Commander and the component.• Power on the components first, if necessary.• Make sure you have pressed the correct Component Select button. In case of CBL/SAT, DVD or DECK B/A, make sure the desired component is displayed.• Check that the component has infrared remote capability. For example, if your component didn't come with a remote commander, it probably isn't capable of being controlled by a remote commander.• You have assigned a different component to the Component Select button. Check the component assigned to that button and the component code.
You cannot control the volume.	<ul style="list-style-type: none">• If your visual components are connected to an audio system, make sure you've set up the Commander as described in "Controlling the Volume of Visual Components Connected to an Audio System" (page 22).• You have assigned another component to the TV or AMP button (page 35). In this case, the volume cannot be controlled when you select a component other than TV or AMP.
You cannot operate the components even after setting the component code numbers.	<ul style="list-style-type: none">• Set the component code correctly. If the code that is listed first for your component doesn't work, try all the codes for your component in the order in which they are listed in the supplied "Component Code Numbers".• Some features may not be preset. If some or all of the keys do not function correctly even after you have set the component codes, then use the learning function to program the remote control signals for the component (page 16).• The component may be operated with a code number that is not listed in the "Component Code Numbers". See "Finding a component code with the Search function" (page 11) and try setting a code number again.
The Commander fails to learn the remote control signals.	<ul style="list-style-type: none">• When you teach signals of an interactive signal exchange system remote control unit (supplied with some of Sony's receivers and amplifiers) to the Commander, the response signal of the main unit may interfere with the learning of the Commander. In such a case, move to a place where the signals will not reach the main unit (e.g. other rooms, etc.).
You cannot operate a component even after you programmed the remote control signals with the "learning" function.	<ul style="list-style-type: none">• Make sure that the Remote Commander has learned the correct signals. If not, see "For accurate learning" (page 20) and try the learning procedure again (page 16).

Troubleshooting (continued)

Symptom	Remedy
You hear beeps (“pip, pip, pip, pip, pip”) and “NG” flashes.	<ul style="list-style-type: none">• Learning has not succeeded. See “For accurate learning” (page 20) and try the learning procedure again (page 16).• The component codes cannot be set. See the supplied “Component Code Numbers” and try setting the component codes again (page 8).• The data have not been transferred. See “Transferring data” (page 41) and try transferring the data again.• The data have not been received. See “Receiving the data” (page 43) and try receiving the data again.
You hear beeps (“pip, pip”) and “NG” flashes.	<ul style="list-style-type: none">• The Preset Lock function is on. Unlock the Preset Lock function (page 48), and try the component code setting or the learning function.• Signals have been programmed for that Component Select or SYSTEM CONTROL button using the learning function. Clear the learned signals (page 34, 40) and try programming the System Control function again.• Signal has been programmed for that key using the learning function. Clear the signal(s) (pages 20 and 21) and try programming the function or the display for the same key again, or try with another Component Select button.• Signals have been programmed for that macro key using the learning function. Clear the learned signals (page 20) and try programming the Channel Macro function for the same key again, or try with another macro key.• There are some keys, on which signals have been programmed, on the display for the Component Select button of the Commander when the commander receives the data from another Commander. Clear the signals (pages 20, 21 and “Notes” on page 44) and try receiving the data again.
“NG” appears during learning.	<ul style="list-style-type: none">• Clear infrequently used learned keys (page 20), then carry out learning operations.
A system control program does not function correctly.	<ul style="list-style-type: none">• Make sure that you have programmed the commands in the correct order (page 23).• Try changing the orientation of the Commander. If that does not help, try placing the components as close to each other as possible.• Check the status of the components and make sure that you have set the components properly to receive commands (page 27).• The component codes are changed or a new signals have been learned for a key or button that has been programmed with a series of commands. In this case, the new signals are transmitted when the series of commands is executed.• The interval may be too short. See “Changing the interval between operation steps” (page 30) and set a longer interval.

Symptom	Remedy
The power of the Commander turns off by itself.	<ul style="list-style-type: none"> This Commander is preset at the factory to switch the power off automatically after 10 minutes if left unused. (Auto Power-Off, page 49) You can change the power-off time from 10 to 90 minutes, or set the Commander not to power off automatically.
The power of the Commander does not turn on when you press a button.	<ul style="list-style-type: none"> The Hold function is on ("OFF" appears on the display). Unlock the Hold function (page 47).
Your Commander does not work as expected after data transfer.	<ul style="list-style-type: none"> Data transfer to/from a single button cannot transfer System Control functions that are learned by Component Select buttons. Either set up the learned Commander from the start, or perform whole data transfer.

Note on the Commanders with the  mark

Data transfer between Commanders with the  mark may not always be complete, depending on their functions and keys, and some of the System Control function data may be dropped.

For the customers in the U.S.A.

Customer Support Information

After you have read through this manual, if you still cannot get the Remote Commander to work properly, call the Sony Customer Support Helpline at 1-800-822-2217.

Table of Preset Functions

Note

There may be some components or functions that cannot be operated with this Commander.

TV

KEY DISPLAY	FUNCTION
POWER	To turn the power on/off
1 - 9, 0, ENTER	To change the channel For example, to change to channel 5, press 0 and 5 (or, press 5 and ENTER)
INPUT	To change the input mode
DISPLAY	To display the current channel on TV
SLEEP	To operate SLEEP function on the TV (works only for a TV with SLEEP function)
WIDE	To switch to WIDE
MENU	To call up the MENU display
↑	To move the cursor upward
↓	To move the cursor downward
→	To move the cursor to the right
←	To move the cursor to the left
EXECUTE	To enter the selection of the MENU display
PIP ON/OFF	To turn on/off the "window" picture*
PIP OFF	To turn off the "window" picture
PIP CH+	To change the TV channel in the "window" picture
PIP INPUT	To change the input mode of the "window" picture
PIP MOVE	To move the location of the "window" picture
PIP STILL	To freeze the "window" picture
PIP SWAP	To swap the "window" picture

KEY DISPLAY	FUNCTION
CHANNEL +/-	Channel up: + Channel down: -
RECALL	To operate JUMP, FLASHBACK or CHANNEL RETURN function on the TV depending on the setting of the TV's manufacturer
VOLUME +/-	Volume up: + Volume down: -
MUTING	To mute the volume on the TV. Press again to turn muting off.

* If the "window" picture does not turn off this way, try pressing the ENTER key while pressing the PIP ON/OFF key.

VCR 1, 2, 3

KEY DISPLAY	FUNCTION
POWER	To turn the power on/off
1 - 9, 0, ENTER	To change the channel For example, to change to channel 5, press 0 and 5 (or, press 5 and ENTER)
INPUT	To change the input mode
DISPLAY	To activate the on-screen display
ANT/SW	To switch the antenna output
MENU	To call the MENU display
↑	To move the cursor upward
↓	To move the cursor downward
→	To move the cursor to the right
←	To move the cursor to the left
EXECUTE	To enter the selection of the MENU display
◀	To rewind
▶	To play
▶▶	To fast-forward
REC	To record, press ▶ while pressing REC.** First release ▶, then release REC.
■	To stop
	To pause
CHANNEL +/-	Channel up: + Channel down: -

**In order to avoid recording by mistake, the REC key does not work by itself. You can assign this operation (record) to a single key using the learning function (page 16).

DVD

KEY DISPLAY	FUNCTION
POWER	To turn to the power on and off
1 - 9, 0	Number buttons: To set items selected from the screen
+10	To select numbers 10 and above
ENTER	To enter a setting or to set items selected from the screen
AUDIO	To change the sound
DISPLAY	To show the current play status on the screen
ANGLE	To switch angle
CLEAR	To clear the selected characters from the screen
RETURN	To return to the last previous screen
TITLE	To display the title menu
SUB TITLE	To switch the subtitle
DVD MENU	To display the DVD menu
↑	To move the cursor upward
↓	To move the cursor downward
→	To move the cursor to the right
←	To move the cursor to the left
EXECUTE	To execute items selected from the screen
◀	To rewind
▶	To play
▶▶	To fast-forward
■	To stop
	To pause
▶▶	To proceed to the next location or song
◀◀	To proceed to the previous location or song

**Table of Preset Functions
(continued)**

VD (Video disc player)

KEY DISPLAY	FUNCTION
POWER	To turn the power on/off
1 - 9, 0	To select the track number (0 selects track 10) To select track numbers above 10, see the descriptions on the +10 button below
+10	To select numbers 10 and above
ENTER	To enter the setting
DISPLAY	To show the current play status on the screen
CLEAR	To clear the selected characters from the screen
A	To select disc side A
B	To select disc side B
◀◀	To rewind
▶	To play
▶▶	To fast-forward
■	To stop
	To pause
▶▶	To proceed to the next location or song
◀◀	To proceed to the previous location or song

CBL (Cable box)

KEY DISPLAY	FUNCTION
POWER	To turn the power on/off
1 - 9, 0, ENTER	To change the channel For example, to change to channel 5, press 0 and 5 (or , press 5 and ENTER)
CHANNEL +/-	Channel up :+ Channel down : -
RECALL	To operate JUMP, FLASHBACK or CHANNEL RETURN function

SAT

KEY DISPLAY	FUNCTION
POWER	To turn the power on/off
1 - 9, 0, ENTER	To change the channel For example, to change to channel 5, press 0 and 5 (or, press 5 and ENTER).
+10	To select numbers 10 and above
INPUT	To switch the output of the SAT receiver to the TV (When you connect a TV cable or antenna to the receiver, the output switches between a TV and SAT program)
DISPLAY	To turn on the display
RECALL	To tune to the last tuned station
FAVORITE	To use the "FAVORITE" function
S.INDEX	To bring up the Station Index
GUIDE	To bring up Master Guide
EXIT	To exit the mode
MENU	To call up the MENU display
↑	To move the cursor upward
↓	To move the cursor downward
→	To move the cursor to the right
←	To move the cursor to the left
EXECUTE	To bring up the Station Index when a program guide is not displayed To select the channel that is highlighted
CHANNEL +/-	Channel up : + Channel down : -

AMP

KEY DISPLAY	FUNCTION
POWER	To turn the power on/off
1 - 9, 0	To use the key directly
ENTER	To enter the setting
VIDEO 1	To select the input source: VIDEO 1
VIDEO 2	To select the input source: VIDEO 2
VIDEO 3	To select the input source: VIDEO 3
AUX/VDP	To select the input source: VDP (LD)
DVD	To select the input source: DVD
TV	To select the input source: TV
CD	To select the input source: CD
MD/DAT	To select the input source: MD
TUNER	To select the input source: TUNER
TAPE	To select the input source: TAPE
PHONO	To select the input source: PHONO
MENU	To call up the MENU display
↑	To move the cursor upward
←	To move the cursor to the left
→	To move the cursor to the right
↓	To move the cursor downward
EXECUTE	To enter the selection of the MENU display

**Table of Preset Functions
(continued)**

KEY DISPLAY	FUNCTION
SHIFT	To shift band or preset select
CHANNEL +/-	Presetting or tuning frequency to a higher: + Presetting or tuning frequency to a lower: -
VOLUME +/-	Volume up: + Volume down: -
MUTING	To mute the volume on the AMP Press again to turn muting off.

CD

KEY DISPLAY	FUNCTION
POWER	To turn the power on/off
1 - 9, 0	To select the track number (0 selects track 10) To select track numbers above 10, see the descriptions on the +10 button below.
+10	To select numbers 10 and above
ENTER	To enter the setting
D.SKIP	To select next disk
REPEAT	To select repeat play mode
CONTINUE	To select continuous play mode
SHUFFLE	To play in random order
PROGRAM	To use for program play
CLEAR	To clear the setting
◀◀	To rewind
▶	To play
▶▶	To fast-forward
■	To stop
	To pause
▶▶	To select the next track
◀◀	To select the previous track

MD

KEY DISPLAY	FUNCTION
POWER	To turn the power on/off
1 - 9, 0	To select the track number (0 selects track 10) To select track numbers above 10, see the descriptions on the +10 button below.
+10	To select numbers 10 and above
ENTER	To enter the setting.
D.SKIP	To select the next disc
DISPLAY	To switch the display mode
CONTINUE	To select continuous play mode
SHUFFLE	To play in random order
PROGRAM	To use for program play
CLEAR	To clear the setting
◀◀	To rewind
▶	To play
▶▶	To fast-forward
REC	To record, press ▶ while pressing REC. First release ▶, then release REC.
■	To stop
	To pause
▶▶	To select the next track
◀◀	To select the previous track

DAT

KEY DISPLAY	FUNCTION
POWER	To turn the power on/off
1 - 9, 0	To select a program number
ENTER	To enter the setting
DISPLAY	To turn on/off the display mode
◀◀	To rewind
▶	To play
▶▶	To fast-forward
REC	To record, press ▶ while pressing REC. First release ▶, then release REC.
■	To stop
	To pause
○	Record muting
▶▶	To proceed to the next song
◀◀	To proceed to the previous song

**Table of Preset Functions
(continued)**

DECK B/A	
KEY DISPLAY	FUNCTION
POWER	To turn the power on/off
◀◀	To rewind
◀	To reverse
▶	To play
▶▶	To fast-forward
REC	To record, press ▶ while pressing REC. First release ▶, then release REC.
■	To stop
	To pause
○	Record muting
A/B	To select the tape deck : Deck A or B (dual cassette deck only)

TUNER	
KEY DISPLAY	FUNCTION
POWER	To turn the power on/off
1 - 9, 0	Number buttons
+10	To select numbers 10 and above
ENTER	To enter the setting
BAND	To select FM/AM
▶	Tuning up
◀	Tuning down
SHIFT	To shift bands or preset select
A	To select the page group A of preset
B	To select the page group B of preset
C	To select the page group C of preset
CHANNEL +/-	Presetting or tuning to a higher frequency: + Presetting or tuning to a lower frequency: -

DSP (Digital Surround Processor)

KEY DISPLAY	FUNCTION
POWER	To turn the power on/off
T.TONE	To make a test tone
SOUND FIELD	To turn on/off the sound fields
GENRE	To select a sound field genre
MODE	To select a sound field mode
▶	Input select >
◀	Input select <
MENU	To call up the MENU display
↑	Digital processing control ^
↓	Digital processing control v
➡	Digital processing control >
⬅	Digital processing control <
CENTER ◇	To adjust the center speaker level
REAR ◇	To adjust the rear speaker level
SUB WOOFER ◇	To adjust the subwoofer level
EFFECT ◇	To control the effect
FRONT BAL <◇	To control the front speaker balance
REAR BAL <◇	To control the rear speaker balance

LCD Touch-Key Display Table

Memo for component select buttons

If you assign other components on Component Select buttons, use the space below as your memo.

	TV	VCR1	VCR2	VCR3	DVD	CBL/SAT
New component →	<input type="text"/>	<input type="text"/>	<input type="text"/>	<input type="text"/>	<input type="text"/>	<input type="text"/>
	AMP	CD	MD/DAT	DECK B/A	TUNER	DSP
New component →	<input type="text"/>	<input type="text"/>	<input type="text"/>	<input type="text"/>	<input type="text"/>	<input type="text"/>

Keys for each component

The followings are the tables of the keys available for each component, which are useful if you use them as a memorandum of learned keys.

TV

RESET	TV					POWER
	C+	C-	V+	V-	MU	
1	2	3	INPUT	PIP ON/OFF	PIP INPUT	PIP MOVE
			DISPLAY	PIP OFF	PIP STILL	PIP SWAP
4	5	6				
			ANT/SW	SLEEP		
7	8	9			MENU	EXECUTE
					↑	
+10	0	ENTER	RECALL	WIDE	←	↓
						→

VCR 1

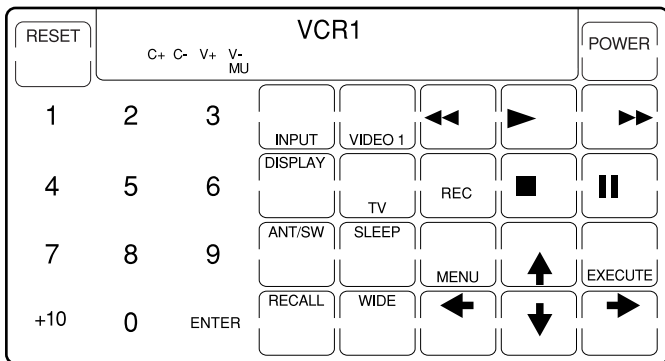

VCR 2

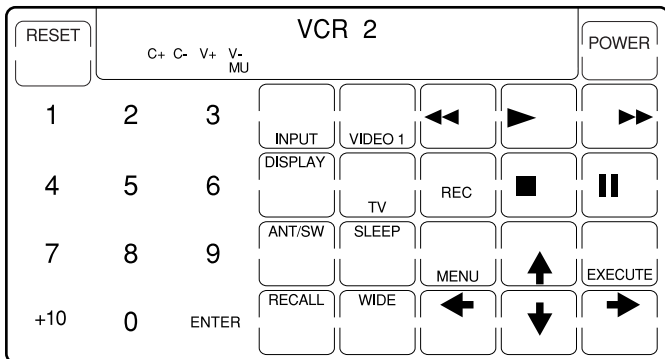

VCR 3

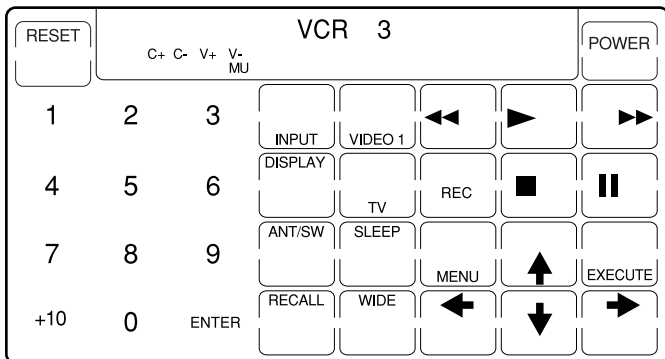

LCD Touch-Key Display Table (continued)

DVD

RESET	DVD				POWER
	C+	C-	V+	V-	MU
1	2	3	AUDIO	VIDEO 1	◀▶▶
4	5	6	DISPLAY	SUB TITLE	EXIT ■
7	8	9	ANGLE	TITLE	DVD MENU ▲ EXECUTE
+10	0	ENTER	CLEAR	RETURN	◀▼▶

**VD
(Video disc
player)**

RESET	VD				POWER
	C+	C-	V+	V-	MU
1	2	3	AUDIO	VIDEO 1	◀▶▶
4	5	6	DISPLAY	TV	CD ■
7	8	9	ANT/SW	TITLE	A B REPEAT
+10	0	ENTER	CLEAR	RETURN	CONTINUE SHUFFLE PROGRAM

CBL (cable box)

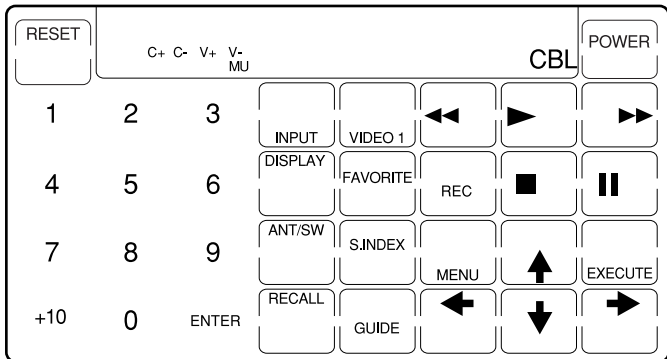

SAT

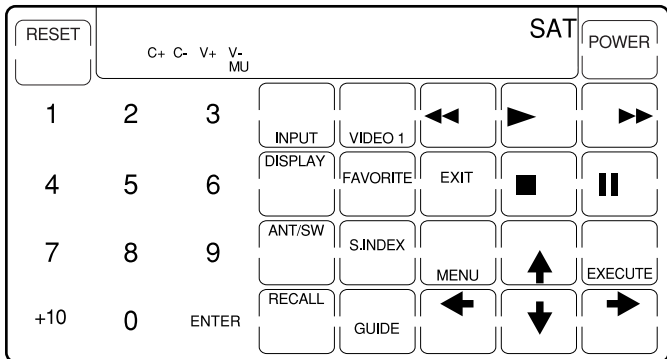

AMP

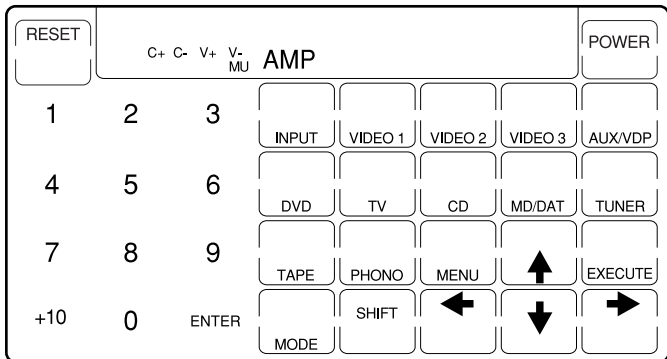

LCD Touch-Key Display Table (continued)

CD

RESET	C+ C- V+ V- MU			CD				POWER
1	2	3	AUDIO	VIDEO 1	◀◀	▶▶	▶▶▶	
4	5	6	DISPLAY	FAVORITE	CD	■	⏸	
7	8	9	TAPE	S.INDEX	A/B	D.SKIP	REPEAT	
+10	0	ENTER	CLEAR	RETURN	CONTINUE	SHUFFLE	PROGRAM	

MD

RESET	C+ C- V+ V- MU			MD				POWER
1	2	3	INPUT	VIDEO 1	◀◀	▶▶	▶▶▶	
4	5	6	DISPLAY	FAVORITE	REC	■	⏸	
7	8	9	TAPE	TITLE	A/B	D.SKIP	○	
+10	0	ENTER	CLEAR	RETURN	CONTINUE	SHUFFLE	PROGRAM	

DAT

RESET	C+ C- V+ V- MU			MD				POWER
1	2	3	INPUT	VIDEO 1	◀◀	▶▶	▶▶▶	
4	5	6	DISPLAY	FAVORITE	REC	■	⏸	
7	8	9	TAPE	TITLE	A/B	D.SKIP	○	
+10	0	ENTER	CLEAR	RETURN	CONTINUE	SHUFFLE	PROGRAM	

DECK A

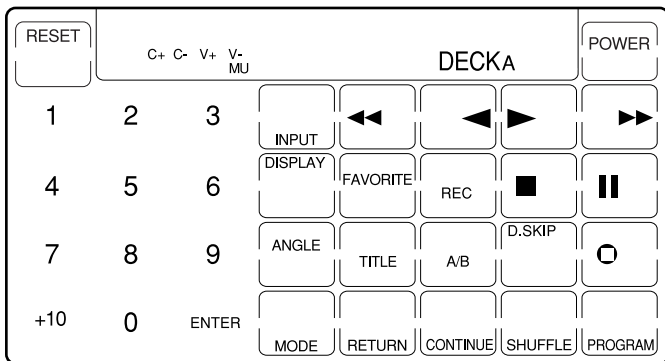

DECK B

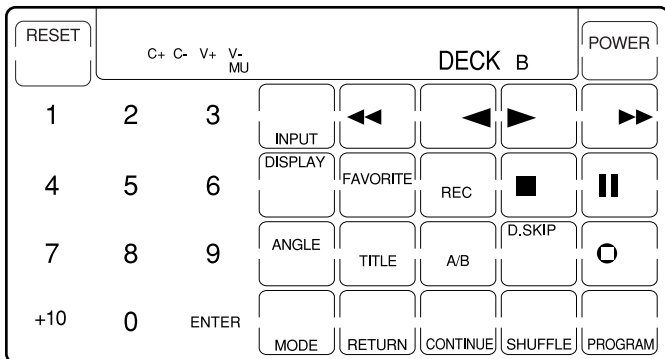

LCD Touch-Key Display Table (continued)

TUNER

RESET	C+ C- V+ V- MU					TUNER			POWER
1	2	3	BAND	VIDEO 1	◀	▶	AUX/VDP		
4	5	6	DISPLAY	FAVORITE	CD	MD/DAT	TUNER		
7	8	9	GENRE	TITLE	A	B	C		
+10	0	ENTER	CLEAR	SHIFT	D	E	PROGRAM		

**DSP
(Digital
Surround
Processor)**

RESET	C+ C- V+ V- MU					DSP			POWER
∧	∧	∧	T.TONE	VIDEO 1	◀	▶	AUX/VDP		
CENTER	REAR	SUB WOOFER	SOUND FIELD	FAVORITE	EXIT	MD/DAT	TUNER		
∨	∨	∨	GENRE	PHONO	MENU	↑	EXECUTE		
< FRONT BAL >		∧	MODE	RETURN	←	↓	→		
< REAR VOL >		∨							

Full display

You can use the following tables as a memorandum for the optional button or for any component.

RESET CHANGE 1 2 OFF		LEARN NG C+ C- V+ V- SC1 SC2 SC3 MU		TV VCR123DVD TUNERSAT AMP CD MDD SP DECK ABC BL				POWER ON OFF							
1		2		3		BAND AUDIO T.TONE INPUT		PIP ON/OFF		PIP INPUT		PIP MOVE		PIP CH+	
CENTER		REAR		SUB WOOFER		VIDEO 1		VIDEO 2		VIDEO 3		AUX/VDP			
4		5		6		DISPLAY SOUND FIELD DVD		PIP OFF FAVORITE SUB TITLE TV		PIP STILL EXIT REC CD		PIP SWAP		PIP CH-	
7 FRONT BAL		8		9		ANT/SW ANGLE GENRE TAPE		SLEEP S.INDEX TITLE PHONO		DVD A MENU A/B MENU		D.SKIP B		REPEAT C	
EFFECT		ENTER				RECALL CLEAR MODE		WIDE SHIFT GUIDE RETURN		D		E		F	
+10 REAR VOL		0								CONTINUE		SHUFFLE		PROGRAM	

RESET CHANGE 1 2 OFF		LEARN NG C+ C- V+ V- SC1 SC2 SC3 MU		TV VCR123DVD TUNERSAT AMP CD MDD SP DECK ABC BL				POWER ON OFF							
1		2		3		BAND AUDIO T.TONE INPUT		PIP ON/OFF		PIP INPUT		PIP MOVE		PIP CH+	
CENTER		REAR		SUB WOOFER		VIDEO 1		VIDEO 2		VIDEO 3		AUX/VDP			
4		5		6		DISPLAY SOUND FIELD DVD		PIP OFF FAVORITE SUB TITLE TV		PIP STILL EXIT REC CD		PIP SWAP		PIP CH-	
7 FRONT BAL		8		9		ANT/SW ANGLE GENRE TAPE		SLEEP S.INDEX TITLE PHONO		DVD A MENU A/B MENU		D.SKIP B		REPEAT C	
EFFECT		ENTER				RECALL CLEAR MODE		WIDE SHIFT GUIDE RETURN		D		E		F	
+10 REAR VOL		0								CONTINUE		SHUFFLE		PROGRAM	

RESET CHANGE 1 2 OFF		LEARN NG C+ C- V+ V- SC1 SC2 SC3 MU		TV VCR123DVD TUNERSAT AMP CD MDD SP DECK ABC BL				POWER ON OFF							
1		2		3		BAND AUDIO T.TONE INPUT		PIP ON/OFF		PIP INPUT		PIP MOVE		PIP CH+	
CENTER		REAR		SUB WOOFER		VIDEO 1		VIDEO 2		VIDEO 3		AUX/VDP			
4		5		6		DISPLAY SOUND FIELD DVD		PIP OFF FAVORITE SUB TITLE TV		PIP STILL EXIT REC CD		PIP SWAP		PIP CH-	
7 FRONT BAL		8		9		ANT/SW ANGLE GENRE TAPE		SLEEP S.INDEX TITLE PHONO		DVD A MENU A/B MENU		D.SKIP B		REPEAT C	
EFFECT		ENTER				RECALL CLEAR MODE		WIDE SHIFT GUIDE RETURN		D		E		F	
+10 REAR VOL		0								CONTINUE		SHUFFLE		PROGRAM	

Quick Reference of Operations

To	Press	For details, see
Set a component code	COMMANDER OFF + MUTING	page 8
Program to the keys or buttons on a component (learning function)	COMMANDER OFF + Component Select	page 16
Assign other components to the Component Select buttons	COMMANDER OFF + CHANNEL- + Component Select	page 35
Change the volume control setting	COMMANDER OFF + VOLUME+ + VOLUME-	page 22
Assign the System Control function to the SYSTEM CONTROL buttons	COMMANDER OFF + SYSTEM CONTROL (1, 2, 3)	page 24
Set the System Power-Off function	COMMANDER OFF + CHANNEL- + VOLUME+	page 34
Program the Power-on command to the Component Select buttons	COMMANDER OFF + VOLUME- + Component Select	page 31
Program a command to the SYSTEM CONTROL buttons or Component Select buttons	COMMANDER OFF + CHANNEL+ + VOLUME+	page 32, 38
Copy the settings of one Component Select button to another	COMMANDER OFF + (copy to) Component Select  (copy to) Component Select + (copy from) Component Select	page 37

To	Press	For details, see
Program a System Control functions for Component Select buttons	COMMANDER OFF + VOLUME+ + Component Select	page 28
Set the desired keys on the display	COMMANDER OFF + CHANNEL+ + Component Select	page 52
Set the interval of the System Control functions	COMMANDER OFF + CHANNEL+ + CHANNEL-	page 30
Transfer data	COMMANDER OFF + VOLUME- + CHANNEL-	page 41
Program a Channel Macro function	COMMANDER OFF + MUTING ↓ CHANNEL+ + Component Select	page 45
Turn the key-touch beep on/off	COMMANDER OFF + MUTING ↓ (ON) VOLUME+ + MUTING (OFF) VOLUME- + MUTING	page 51
Set the Auto Power-Off time	COMMANDER OFF + CHANNEL+ + VOLUME-	page 49
Set the Auto-Off time/brightness of the Backlight	COMMANDER OFF + LIGHT	page 50
Lock the Remote Commander	CHANGE + COMMANDER OFF	page 47

Index

A

- Auto Power-Off
 - of the Commander 49
 - of the backlight 50

B

- Backlight
 - adjusting 50
 - Auto Power-Off 49
 - batteries 6
- Batteries 6

C, D

- Changing
 - function display of keys 19
 - interval of the System Control function 30
 - time of Auto Power-off 49
 - touch-key display 52
- CHANNEL button 7
- Channel Macro function 45
- Clearing/Changing
 - Channel Macro function 46
 - learned signal 20, 34, 40
 - System Control function 26, 29
- Code number 8
- Component Select buttons
 - assigning other components 35
 - copying settings 37
 - programming a signal 31
 - programming System Control function 28
 - receiving data 43
 - setting Power-On function 31
 - transferring data 41
- COMMANDER OFF button 7

- Copying
 - data to another commander 41
 - settings of Component Select buttons 37

E

- Erasing
 - See "Clearing/Changing"

F, G

- Factory setting 8, 22, 26

H

- Hold Function 47

I, J

- Input select 15

K

- Key touch beep 51

L

- LCD
 - Auto-Off time 49
 - brightness 50
 - display type 52
 - touch keys 66
- Learning Function 16, 33, 38
- LIGHT button 7, 50
- Locking
 - control of Commander 47
 - settings on Commander 48

M, N, O

- MUTING button 7, 14, 17, 22

P, Q

- Power-On function
 - setting 31
 - SYSTEM CONTROL3 button 26
- Power-Off function
 - See "System Power-Off function"
 - See "Auto Power-off"

- Preset components 8
- Preset Lock Function 48

R

- Receiving data 43

S

- SYSTEM CONTROL
 - buttons
 - programming a signal 38
 - programming System control function 23
- System Control function
 - changing interval 30
 - clearing 26, 29
 - programming 23, 28
- System Power-Off function
 - setting 34
- SYSTEM CONTROL 1
 - button 26

T, U

- Transferring data 41
- Troubleshooting 55

V, W, X, Y, Z

- VOLUME buttons 7, 14, 17, 22
- Volume Control 14, 22